

# **User Manual**



**RFA300A**  
**Measurement Set 8VSB**  
**071-0697-01**

Copyright © Tektronix, Inc. All rights reserved.

Tektronix products are covered by U.S. and foreign patents, issued and pending. Information in this publication supercedes that in all previously published material. Specifications and price change privileges reserved.

Tektronix, Inc., P.O. Box 500, Beaverton, OR 97077

TEKTRONIX and TEK are registered trademarks of Tektronix, Inc.

## WARRANTY

Tektronix warrants that the products that it manufactures and sells will be free from defects in materials and workmanship for a period of one (1) year from the date of shipment. If a product proves defective during this warranty period, Tektronix, at its option, either will repair the defective product without charge for parts and labor, or will provide a replacement in exchange for the defective product.

In order to obtain service under this warranty, Customer must notify Tektronix of the defect before the expiration of the warranty period and make suitable arrangements for the performance of service. Customer shall be responsible for packaging and shipping the defective product to the service center designated by Tektronix, with shipping charges prepaid. Tektronix shall pay for the return of the product to Customer if the shipment is to a location within the country in which the Tektronix service center is located. Customer shall be responsible for paying all shipping charges, duties, taxes, and any other charges for products returned to any other locations.

This warranty shall not apply to any defect, failure or damage caused by improper use or improper or inadequate maintenance and care. Tektronix shall not be obligated to furnish service under this warranty a) to repair damage resulting from attempts by personnel other than Tektronix representatives to install, repair or service the product; b) to repair damage resulting from improper use or connection to incompatible equipment; c) to repair any damage or malfunction caused by the use of non-Tektronix supplies; or d) to service a product that has been modified or integrated with other products when the effect of such modification or integration increases the time or difficulty of servicing the product.

**THIS WARRANTY IS GIVEN BY TEKTRONIX IN LIEU OF ANY OTHER WARRANTIES, EXPRESS OR IMPLIED. TEKTRONIX AND ITS VENDORS DISCLAIM ANY IMPLIED WARRANTIES OF MERCHANTABILITY OR FITNESS FOR A PARTICULAR PURPOSE. TEKTRONIX' RESPONSIBILITY TO REPAIR OR REPLACE DEFECTIVE PRODUCTS IS THE SOLE AND EXCLUSIVE REMEDY PROVIDED TO THE CUSTOMER FOR BREACH OF THIS WARRANTY. TEKTRONIX AND ITS VENDORS WILL NOT BE LIABLE FOR ANY INDIRECT, SPECIAL, INCIDENTAL, OR CONSEQUENTIAL DAMAGES IRRESPECTIVE OF WHETHER TEKTRONIX OR THE VENDOR HAS ADVANCE NOTICE OF THE POSSIBILITY OF SUCH DAMAGES.**



# Table of Contents

<b>General Safety Summary</b> .....	vii
<b>Preface</b> .....	<b>ix</b>
Related Documentation .....	ix
Contacting Tektronix .....	x

## Getting Started

<b>Getting Started</b> .....	<b>1-1</b>
Product Description .....	1-1
Accessories .....	1-4
<b>Installation</b> .....	<b>1-5</b>
Check the Shipping List .....	1-5
Operating Requirements .....	1-6
Hardware Installation .....	1-6
Creating a Startup Disk .....	1-13
RF Connections .....	1-14
Interface Connections .....	1-16
Keyboard and Mouse Connections .....	1-16
Powering On and Off .....	1-17
Selecting RF Input Channel and Channel Frequency .....	1-18
Incoming Inspection .....	1-20

## Operating Basics

<b>Operating Basics</b> .....	<b>2-1</b>
Front Panel .....	2-1
Home Window .....	2-4
Making a Measurement .....	2-6
Online Help .....	2-9
Backing Up Files .....	2-10

## Reference

<b>RFA300A Reference</b> .....	<b>3-1</b>
Out of Channel Emissions .....	3-1
S/N, EVM, and Pilot Amplitude Error .....	3-3
Phase Noise .....	3-4
Frequency Response and Group Delay .....	3-6
Amplitude and Phase Errors .....	3-8
Peak-to-Average and Channel Spectrum .....	3-10
Signal Monitor .....	3-12
8VSB Overview .....	3-14
Closed-Loop Transmitter Control .....	3-18

## Appendices

<b>Appendix A: Specifications</b> .....	<b>A-1</b>
Specification Tables .....	A-1
Performance Conditions .....	A-1
RFA300A Measurement Set Specifications .....	A-2
Measurement Specifications .....	A-4
Platform Characteristics .....	A-9
Power Characteristics .....	A-13
Environmental Characteristics .....	A-14
Electromagnetic Compatibility .....	A-16
Mechanical (Physical) Characteristics .....	A-18
<b>Appendix B: User Service</b> .....	<b>B-1</b>
General Care .....	B-1
Preventive Maintenance .....	B-1
In Case of Problems .....	B-3
Repackaging for Shipment .....	B-5
<b>Appendix C: System Recovery</b> .....	<b>C-1</b>
Overview .....	C-1
Restore the BIOS Settings .....	C-3
Restore the Contents of the Partitions .....	C-4
Install and Configure Individual Components .....	C-6
<b>Appendix D: Mask File Formatting</b> .....	<b>D-1</b>

## Glossary

## Index

# List of Figures

<b>Figure 1-1: RFA300A 8VSB Measurement Set front panel</b> .....	<b>1-2</b>
<b>Figure 1-2: Home window</b> .....	<b>1-3</b>
<b>Figure 1-3: Attaching the extension brackets to the stationary tracks</b> .....	<b>1-8</b>
<b>Figure 1-4: Mounting hole selection on the front rails of the equipment rack</b> .....	<b>1-8</b>
<b>Figure 1-5: Attaching the extension bracket to the rear rail of the equipment rack</b> .....	<b>1-9</b>
<b>Figure 1-6: Mounting the stationary section to the front rail of the equipment rack</b> .....	<b>1-10</b>
<b>Figure 1-7: Stationary bracket, extension bracket, and attaching screws</b> .....	<b>1-10</b>
<b>Figure 1-8: Installing the instrument into the equipment rack</b> ....	<b>1-11</b>
<b>Figure 1-9: Transmitter connection</b> .....	<b>1-14</b>
<b>Figure 1-10: Rear view</b> .....	<b>1-15</b>
<b>Figure 1-11: Keyboard and mouse connections</b> .....	<b>1-16</b>
<b>Figure 1-12: On/Standby switch</b> .....	<b>1-17</b>
<b>Figure 1-13: System setup</b> .....	<b>1-19</b>
<b>Figure 2-1: Front panel</b> .....	<b>2-1</b>
<b>Figure 2-2: Home window</b> .....	<b>2-4</b>
<b>Figure 2-3: Toolbar</b> .....	<b>2-5</b>
<b>Figure 2-4: Help menu</b> .....	<b>2-9</b>
<b>Figure 3-1: Out of Channel Emissions measurement window</b> .....	<b>3-2</b>
<b>Figure 3-2: Out of Channel Emissions setup</b> .....	<b>3-2</b>
<b>Figure 3-3: S/N, EVM, and Pilot Amplitude measurement window</b> .....	<b>3-3</b>
<b>Figure 3-4: Phase Noise Measurement window</b> .....	<b>3-5</b>
<b>Figure 3-5: Phase Noise setup</b> .....	<b>3-5</b>
<b>Figure 3-6: Frequency Response and Group Delay measurement window</b> .....	<b>3-7</b>
<b>Figure 3-7: Frequency Response and Group Delay setup</b> .....	<b>3-7</b>
<b>Figure 3-8: Amplitude and Phase Errors measurement window</b> ...	<b>3-9</b>
<b>Figure 3-9: Amplitude Error and Phase Error setup</b> .....	<b>3-9</b>
<b>Figure 3-10: Peak-to-Average and Channel Spectrum measurement window</b> .....	<b>3-10</b>

<b>Figure 3-11: Peak-to-Average Setup</b> .....	<b>3-11</b>
<b>Figure 3-12: Signal Monitor measurement window</b> .....	<b>3-12</b>
<b>Figure 3-13: Signal Monitor Setup</b> .....	<b>3-13</b>
<b>Figure 3-14: 8VSB exciter block diagram</b> .....	<b>3-14</b>
<b>Figure 3-15: Data interleaving</b> .....	<b>3-15</b>
<b>Figure 3-16: Data segment sync</b> .....	<b>3-16</b>
<b>Figure 3-17: Frame synchronizing segment</b> .....	<b>3-17</b>
<b>Figure A-1: IF filter characteristics</b> .....	<b>A-3</b>
<b>Figure A-2: 8VSB transmitter emissions mask</b> .....	<b>A-8</b>
<b>Figure B-1: Repackaging the instrument (new packaging)</b> .....	<b>B-6</b>
<b>Figure B-2: Repackaging the instrument (old packaging)</b> .....	<b>B-8</b>
<b>Figure B-3: Placement of bottom spacer pad in inner shipping box</b>	<b>B-9</b>



## List of Tables

<b>Table 1-1: Standard accessories</b> .....	<b>1-4</b>
<b>Table 1-2: Optional accessories</b> .....	<b>1-4</b>
<b>Table 1-3: Operating requirements</b> .....	<b>1-6</b>
<b>Table 2-1: Front panel-key controls</b> .....	<b>2-2</b>
<b>Table 2-2: Control key combination functions</b> .....	<b>2-3</b>
<b>Table 2-3: Toolbar functions</b> .....	<b>2-5</b>
<b>Table A-1: Input specifications</b> .....	<b>A-2</b>
<b>Table A-2: Measurement specifications</b> .....	<b>A-4</b>
<b>Table A-3: System components</b> .....	<b>A-9</b>
<b>Table A-4: Front panel interface characteristics</b> .....	<b>A-10</b>
<b>Table A-5: Rear panel interface characteristics</b> .....	<b>A-11</b>
<b>Table A-6: AC power source characteristics</b> .....	<b>A-13</b>
<b>Table A-7: Environmental characteristics</b> .....	<b>A-14</b>
<b>Table A-8: Dynamics</b> .....	<b>A-15</b>
<b>Table A-9: Transportation</b> .....	<b>A-15</b>
<b>Table A-10: Certifications and compliances</b> .....	<b>A-16</b>
<b>Table A-11: Mechanical characteristics</b> .....	<b>A-18</b>
<b>Table B-1: Troubleshooting</b> .....	<b>B-4</b>
<b>Table D-1: ResultID Values for Mask Tests</b> .....	<b>D-2</b>



# General Safety Summary

Review the following safety precautions to avoid injury and prevent damage to this product or any products connected to it. To avoid potential hazards, use this product only as specified.

*Only qualified personnel should perform service procedures.*

## **To Avoid Fire or Personal Injury**

**Use Proper Power Cord.** Use only the power cord specified for this product and certified for the country of use.

**Ground the Product.** This product is grounded through the grounding conductor of the power cord. To avoid electric shock, the grounding conductor must be connected to earth ground. Before making connections to the input or output terminals of the product, ensure that the product is properly grounded.

**Observe All Terminal Ratings.** To avoid fire or shock hazard, observe all ratings and markings on the product. Consult the product manual for further ratings information before making connections to the product.

**Do Not Operate Without Covers.** Do not operate this product with covers or panels removed.

**Use Proper Fuse.** Use only the fuse type and rating specified for this product.

**Avoid Exposed Circuitry.** Do not touch exposed connections and components when power is present.

**Do Not Operate With Suspected Failures.** If you suspect there is damage to this product, have it inspected by qualified service personnel.

**Do Not Operate in Wet/Damp Conditions.**

**Do Not Operate in an Explosive Atmosphere.**

**Keep Product Surfaces Clean and Dry.**

**Provide Proper Ventilation.** Refer to the manual's installation instructions for details on installing the product so it has proper ventilation.

**Symbols and Terms**

**Terms in this Manual.** These terms may appear in this manual:



---

**WARNING.** *Warning statements identify conditions or practices that could result in injury or loss of life.*

---



---

**CAUTION.** *Caution statements identify conditions or practices that could result in damage to this product or other property.*

---

**Terms on the Product.** These terms may appear on the product:

DANGER indicates an injury hazard immediately accessible as you read the marking.

WARNING indicates an injury hazard not immediately accessible as you read the marking.

CAUTION indicates a hazard to property including the product.

**Symbols on the Product.** The following symbols may appear on the product:



CAUTION  
Refer to Manual



Protective Ground  
(Earth) Terminal

# Preface

This manual contains operating information for the RFA300A Measurement Set 8VSB. The manual consists of the following sections:

- *Chapter 1: Getting Started.* Provides a product description, installation procedures, connection information, and information on getting the instrument ready for use.
- *Chapter 2: Operating Basics.* Provides basic information about using the instrument.
- *Chapter 3: Reference.* Contains an overview of each measurement window and of the 8VSB standard.
- *Appendix A: Specifications.* Lists the environmental, physical, and electrical properties of the instrument.
- *Appendix B: User Service.* Provides user service information including general care, preventive maintenance, troubleshooting, and repackaging.
- *Appendix C: Software Installation.* Describes how to format a hard drive and reinstall the operating system software and associated hardware drivers.
- *Appendix D: Mask File Formatting.* Describes how to format a mask file using a text editor.

## Related Documentation

In addition to this user manual, the following documentation is available for your measurement set.

- The online help provides information about using the measurement set. To view online help, select Help Topics from the Help menu.
- The optional *RFA300A Measurement Set 8VSB Service Manual* provides board-level service information.

## Contacting Tektronix

<b>Phone</b>	1-800-833-9200*
<b>Address</b>	Tektronix, Inc. Department or name (if known) 14200 SW Karl Braun Drive P.O. Box 500 Beaverton, OR 97077 USA
<b>Web site</b>	<a href="http://www.tektronix.com">www.tektronix.com</a>
<b>Sales support</b>	1-800-833-9200, select option 1*
<b>Service support</b>	1-800-833-9200, select option 2*
<b>Technical support</b>	Email: <a href="mailto:techsupport@tektronix.com">techsupport@tektronix.com</a> 1-800-833-9200, select option 3* 6:00 a.m. - 5:00 p.m. Pacific time

---

\* **This phone number is toll free in North America. After office hours, please leave a voice mail message. Outside North America, contact a Tektronix sales office or distributor; see the Tektronix web site for a list of offices.**

# Getting Started

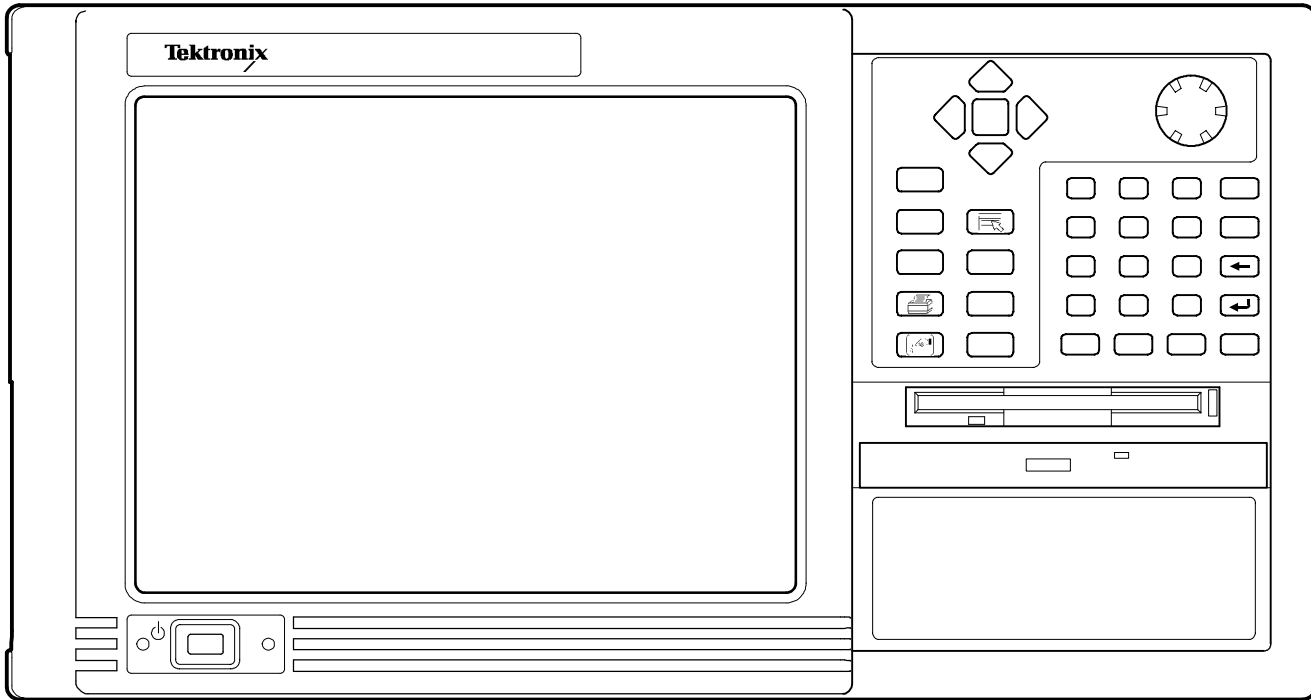
This chapter provides basic information about using and installing the RFA300A Measurement Set 8VSB. There is information about the physical instrument and introductory material on how to operate it. Once you have a basic understanding, proceed to the next chapter, *Operating Basics*, to form a conceptual model of how the measurement set works.

## Product Description

The measurement set provides information on 8VSB digital television signals in conformance with the ATSC Digital Television Standard. Signals are acquired at the transmitter and the measurements consist of the following:

- Complex Modulation Error Ratio
- Signal to Noise Ratio
- Error Vector Magnitude
- Pilot Amplitude Error
- Out-of-Channel Emissions
- Frequency Response Error
- Group Delay
- Amplitude Error
- Phase Error
- Phase Noise Error
- Peak to Average Ratio
- Channel Spectrum (display of the selected channel, not a measurement)

The instrument's measurements can run continuously, thereby monitoring transmitter performance on a constant basis. Operation of the instrument is controlled from the front panel keypad and the touch screen or from an attached keyboard and mouse. Figure 1-1 shows the front panel of the measurement set.



**Figure 1-1: RFA300A 8VSB Measurement Set front panel**

The measurement set uses the Microsoft Windows NT operating system. The Home window is the point-of-entry into the program. Access each measurement from the Home window by clicking on the appropriate icon as shown in Figure 1-2 on page 1-3.



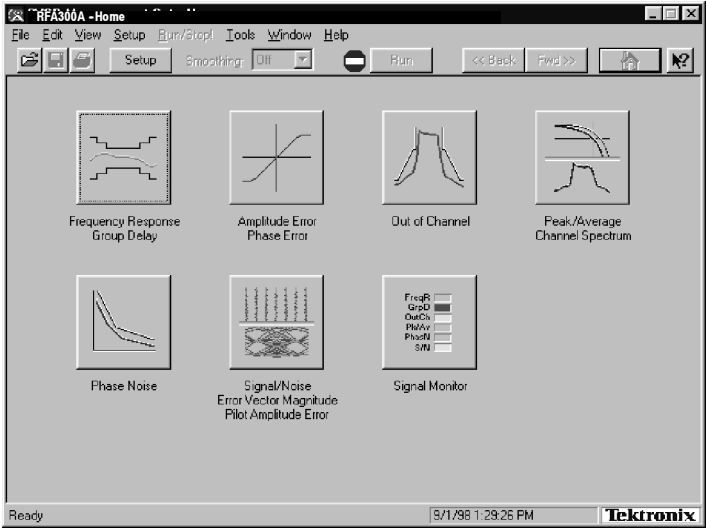


Figure 1-2: Home window

Refer to the next chapters *Operating Basics* and *Reference* for an overview on operating the measurement set. For detail information, refer to the online help.

## Accessories

Table 1-1 and Table 1-2 list the standard and optional accessories.

**Table 1-1: Standard accessories**

Description	Quantity	Part number
RFA300A Measurement Set 8VSB User Manual	1	071-0697-XX
RFA300A Measurement Set 8VSB Application Software on CD-ROM	1	063-3410-XX
Windows NT Software and manual on CD-ROM	1	119-5514-XX
WINNT keyboard (US)	1	119-6216-XX
Tektronix three-button mouse	1	119-4330-XX
Standard IEC power cord, 125 V	1	161-0104-00
Front protective cover	1	200-4408-XX
10 dB Attenuator	1	119-6328-00
Rackmount slides hardware kit	1	-----

**Table 1-2: Optional accessories**

Description	Quantity	Part number
Accessory pouch	1	016-1441-XX
Power cord options		
Opt. A1 Universal Euro 230 V, 50 Hz	1	161-0104-06
Opt. A4 North America 240 V, 60 Hz	1	161-0104-08
Portable cabinet kit w/ instructions	1	016-1929-XX
Option D1, Calibration certificate	1	-----
RFA300A Measurement Set 8VSB Service Manual with Performance Procedure and Adjustment Procedure software disk	1	071-0698-XX 063-3411-XX

# Installation

Read this section before attempting any installation procedures. This section describes site considerations, power requirements, and ground connections for your instrument.

## Check the Shipping List

Verify that you have received all of the parts of your measurement set. Use the shipping lists that came with your instrument to compare against the actual contents of your order. You should also do the following:

- Verify that you have the correct power cord for your geographical area.
- Verify that you have the CD that contains a backup copy of the installed software. Store the CD in a safe location where you can easily retrieve the software for maintenance purposes.
- Verify that you have a boot disk in case you reformat the hard drive or damage operating system files or drivers.

---

**NOTE.** *Keep the software packaging available. You will need it to enter the Windows NT software registration number when you first power on the analyzer. (See step 3 under Powering On and Off on page 1-18.)*

---

- Verify that you have all the other standard and optional accessories that you ordered.

## Operating Requirements

Table 1-3 lists the operating requirements. Refer to *Appendix A: Specifications* for a complete specification list.

**Table 1-3: Operating requirements**

Requirement	Specification
Source voltage	90-250 VAC <sub>RMS</sub> , 47-63 Hz
Steady State input current	6 A <sub>RMS</sub> maximum, 1.9 A typical
Maximum power consumption	540W
Temperature	+5 °C to +45 °C (32 °F to 113 °F), 30 °C/hr max gradient, non-condensing (derated 1 °C per 1,000 ft. above 5,000 ft. altitude)
Humidity	20% to 80% relative humidity, non-condensing. Max wet bulb temperature: +31 °C (derates relative humidity to ~50% @ 50 °C).
Altitude	To 10,000 ft. (3,040 m), (derated 1 °C per 1,000 ft. above 5,000 ft. altitude).

Before you can operate the product, you must connect the provided power cord. Refer to Figure 1-10 and connect the power cord to the instrument. Refer to Table 1-3 for the supply voltage rating and connect the other end of the power cord to the proper source. Do not connect to any power sources other than those for which the instrument is rated.

## Hardware Installation

This section deals with hardware installation. To reinstall software, refer to *Appendix C: System Recovery*.

The factory installed cabinet is designed to operate in an equipment rack (see *Rackmount Installation* on page 1-7). The optional portable cabinet allows you to operate the instrument on a bench or cart (see *Portable Installation* on page 1-12). For proper cooling, at least two inches (5.1 cm) of clearance is recommended on the rear and sides of the instrument cabinet.

The measurement set is limited to installations where a single, high-amplitude, 8VSB RF signal is available for direct input to the measurement set. Refer to *RF Connections* on page 1-14.

## Rackmount Installation

If your instrument has the rackmount cabinet, there is rackmounting hardware on each side of the cabinet.



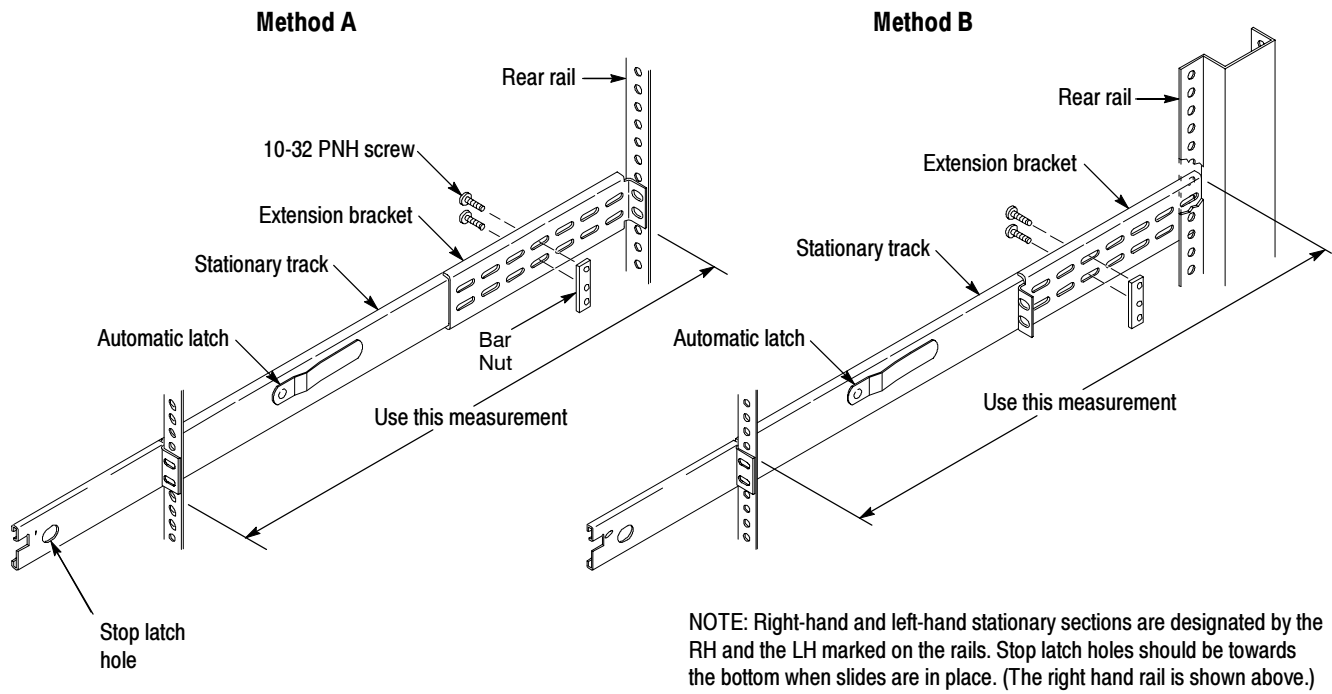
---

**CAUTION.** *For proper cooling in an equipment rack installation, the air temperature at all air intake vents (inside of the rack) must not exceed 50 °C.*

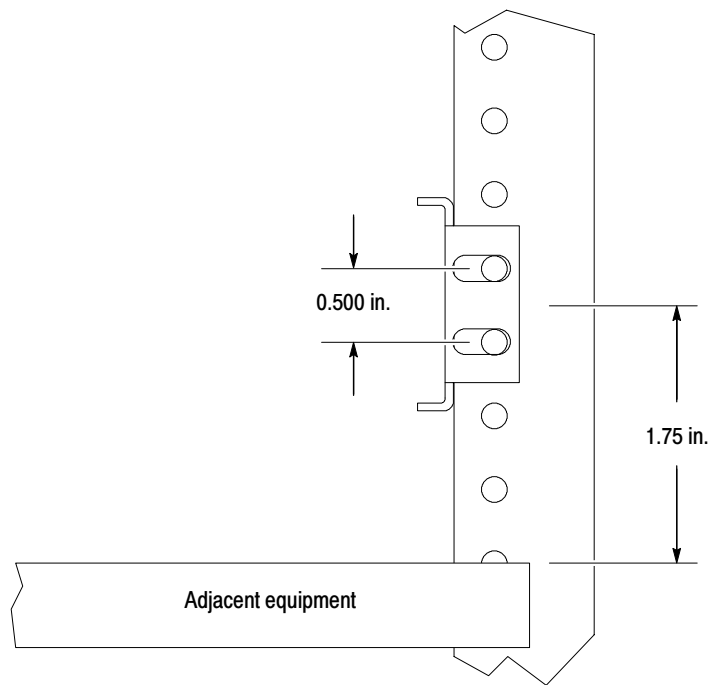
---

**Mounting the Stationary Tracks in the Equipment Rack.** The slider kit consists of left and right stationary tracks that must be installed in the equipment rack. Extra hardware is provided with the slider assemblies. Since the hardware is intended to make the sliders compatible with a variety of racks and installation methods, not all of the hardware will be used for any installation procedure.

1. Attach the extension bracket to the rear of the stationary track.
  - a. Measure the distance between the front and rear rails of the equipment rack using method A or method B. Refer to Figure 1-3.
    - Method A. If the extension bracket is to be mounted against the front edge of the rear rail in the equipment rack, measure from the front edge of the rear rail to the front edge of the front rail.
    - Method B. If the extension bracket is to be mounted against the inside surface of the rear rail in the equipment rack, measure from the front corner of the rear rail to the front edge of the front rail.
  - b. Attach the extension bracket to the rear of the stationary track so that the length of the combined assembly is approximately that of the measurement taken in step a. above. Use the screws and bar nuts provided with the chassis tracks. Leave the screws loose.
2. Select the appropriate mounting holes in the front rails of the equipment rack, observing the clearance measurements shown in Figure 1-4. The front panel of the rack adapter is designed to fit in an 11-inch high opening.



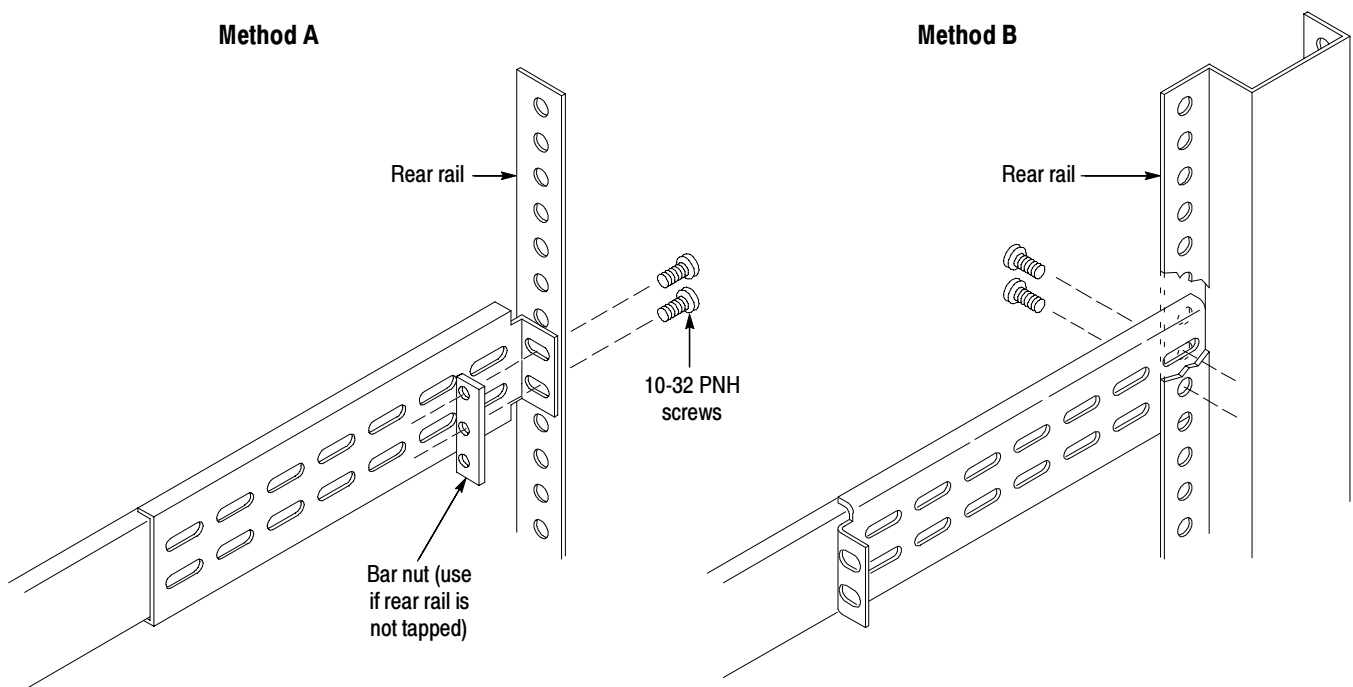
**Figure 1-3: Attaching the extension brackets to the stationary tracks**



**Figure 1-4: Mounting hole selection on the front rails of the equipment rack**

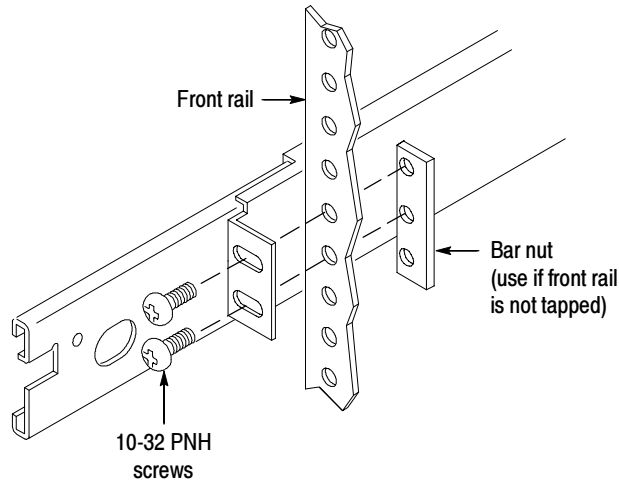
3. Mount the stationary sections (with extension brackets attached) to the front and rear rails of the equipment rack.
  - a. Install the rear of the stationary section in front of, behind, or beside the rear rail of the equipment rack. Use the mounting holes in the rear rails that correspond to the same level as the front rail holes selected.

If the rear-rail mounting holes are tapped, the bar nut is not used to attach the extensions. If the rear-rail mounting holes are not tapped, use the bar nut on the inside of the rail, as shown in Figure 1-5A or use suitable captive nut clips (not supplied). Figure 1-5B shows the extension bracket mounted to the inside surface of the rear rail.



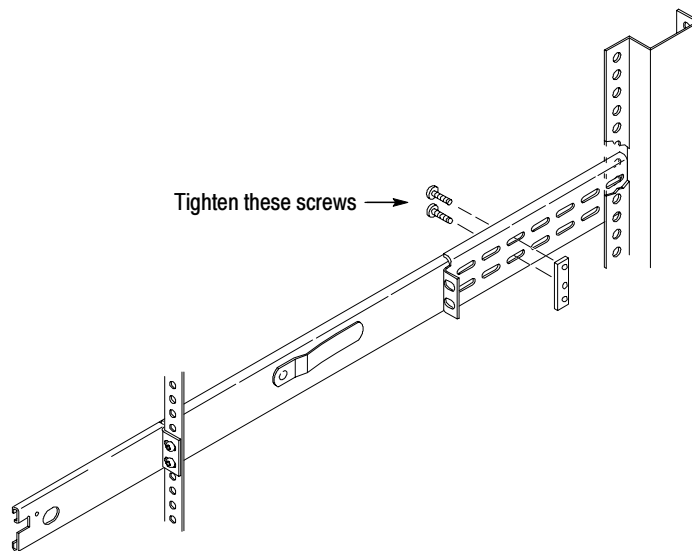
**Figure 1-5: Attaching the extension bracket to the rear rail of the equipment rack**

- b. Mount the stationary sections (with the bracket extensions) to the front rails. If the front rails are not tapped, use the bar nuts. Refer to Figure 1-6.



**Figure 1-6: Mounting the stationary section to the front rail of the equipment rack**

- 4. Tighten the screws attaching the extension bracket to the stationary section. Refer to Figure 1-7.

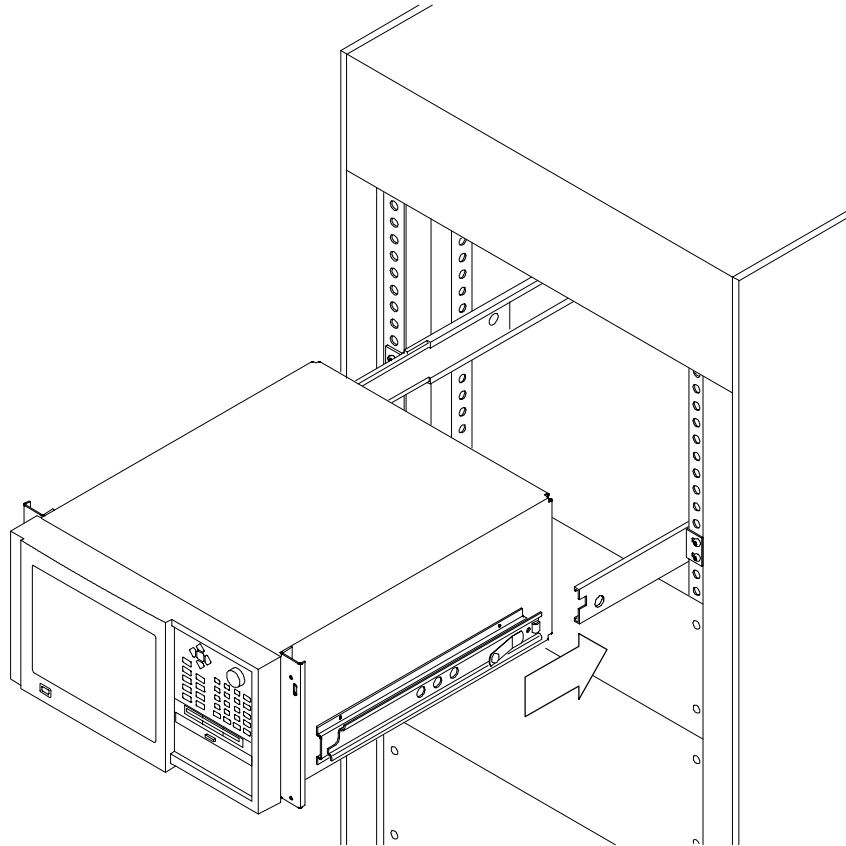


**Figure 1-7: Stationary bracket, extension bracket, and attaching screws**



**Installing the Instrument in the Equipment Rack.** Perform the following steps to install the instrument in the equipment rack:

1. Pull out the intermediate sections of each slide-out track to the fully extended position. Refer to Figure 1-8.
2. Insert the tracks of the rack adapter into the slide-out intermediate sections.
3. Press both stop latch releases and push the rack adapter toward the rack until the latches snap into their holes.
4. Again press the stop latches and push the rack adapter fully into the equipment rack.



**Figure 1-8: Installing the instrument into the equipment rack**

5. If necessary, adjust the alignment of the stationary sections according to the following procedure:
  - a. Loosen the mounting screws at the front of both stationary sections.
  - b. Allow the tracks to seek their normal positions with the adapter centered in the rack.
  - c. Tighten the mounting screws.

### Portable Installation

The optional portable cabinet allows you to operate the instrument on a bench or cart. If you operate the instrument while it rests on the rear feet, make sure that you properly route any cables coming out of the rear of the instrument to avoid damaging them. Table 1-2 on page 1-4 lists the part number of the portable cabinet.



---

**CAUTION.** *Keep the bottom of the instrument clear of obstructions to ensure proper cooling.*

---

## Creating a Startup Disk

An RFA300A Windows NT Start Up disk is shipped with the instrument. Use this disk to restart your measurement set in case of a major hardware or software failure. This section creates an extra startup disk in case the original becomes corrupted.

All software is installed at the factory. If you ever need to reinstall, refer to *Appendix C: Software Installation*.

---

**NOTE.** *You cannot reinstall software without a startup disk.*

---

To create a startup disk, do the following:

1. Open **My Computer/Control Panel**, and double-click on **Add/Remove Programs**.
2. Select the **Startup Disk** tab.
3. Click the **Create Disk** button and follow instructions.
4. Copy the following files to the startup disk:
  - C:REALMODE\MSCDEX.EXE
  - C:REALMODE\TEAC\_CDI.SYS
  - C:WINDOWS\COMMAND\XCOPY.EXE
  - C:WINDOWS\COMMAND\XCOPY32.EXE
5. Create a file named AUTOEXEC.BAT in the startup disk. Add the line MSCDEX.EXE /D:TEAC-CDI/L:D to the file.
6. Open the **CONFIG.SYS** file in the startup disk and add DEVICE=TEAC\_CDLSYS /D:TEAC-CDI to the end file.

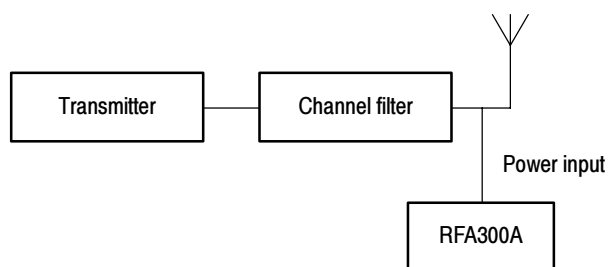
## RF Connections

The quality of the input signal path is critical in obtaining the full-specified performance of the measurement set. Therefore, you must connect the measurement set to your transmitter using high quality cable and connectors. The following list provides the requirements needed for the RF connection:

- Hold the nonflatness of the input signal to approximately 0.05 dB peak-to-peak or less over the width of the channel.
- Keep the station's radiated signal to at least 63 dB down from the sampled signal in the line by using appropriate shielding.
- The cable with connectors must have a return loss of at least 26 dB ( $VSWR \leq 1.10$ ) over the channel width and a loss tilt of less than .02 dB over the channel width. This assumes that the tap used to obtain the signal has a return loss of  $\geq 30$  dB ( $VSWR \leq 1.065$ ).

High quality cable and connectors are required to meet the listed requirements. The connectors should be precision grade at both ends of the cable. The best cable type is dependent on the run length and operating frequency. The return loss requirement is hardest to meet at high frequencies, and the loss tilt is hardest to meet at low frequencies. In either case, minimize the difficulties by using only a few feet for cable length. Longer lengths (50 ft. or more) place extreme requirements on cable quality specifications.

The rear panel provides two RF input connectors for your transmitted signal. Refer to Figures 1-9 and 1-10 to connect the measurement set to your transmitter and for other connections.



**Figure 1-9: Transmitter connection**

Connect the measurement set to your transmitter in a manner that ensures the instrument will receive only one channel. If the input signal strength is more than 1 watt, install the external 10 dB attenuator (the input signal strength cannot be more than 2 watts).

**NOTE.** Power to the measurement set must be within the following ranges:

> 1 mW and < 1 W without the external 10 dB attenuator.

> 10 mW and less  $\leq$  2 W with the external 10 dB attenuator installed.

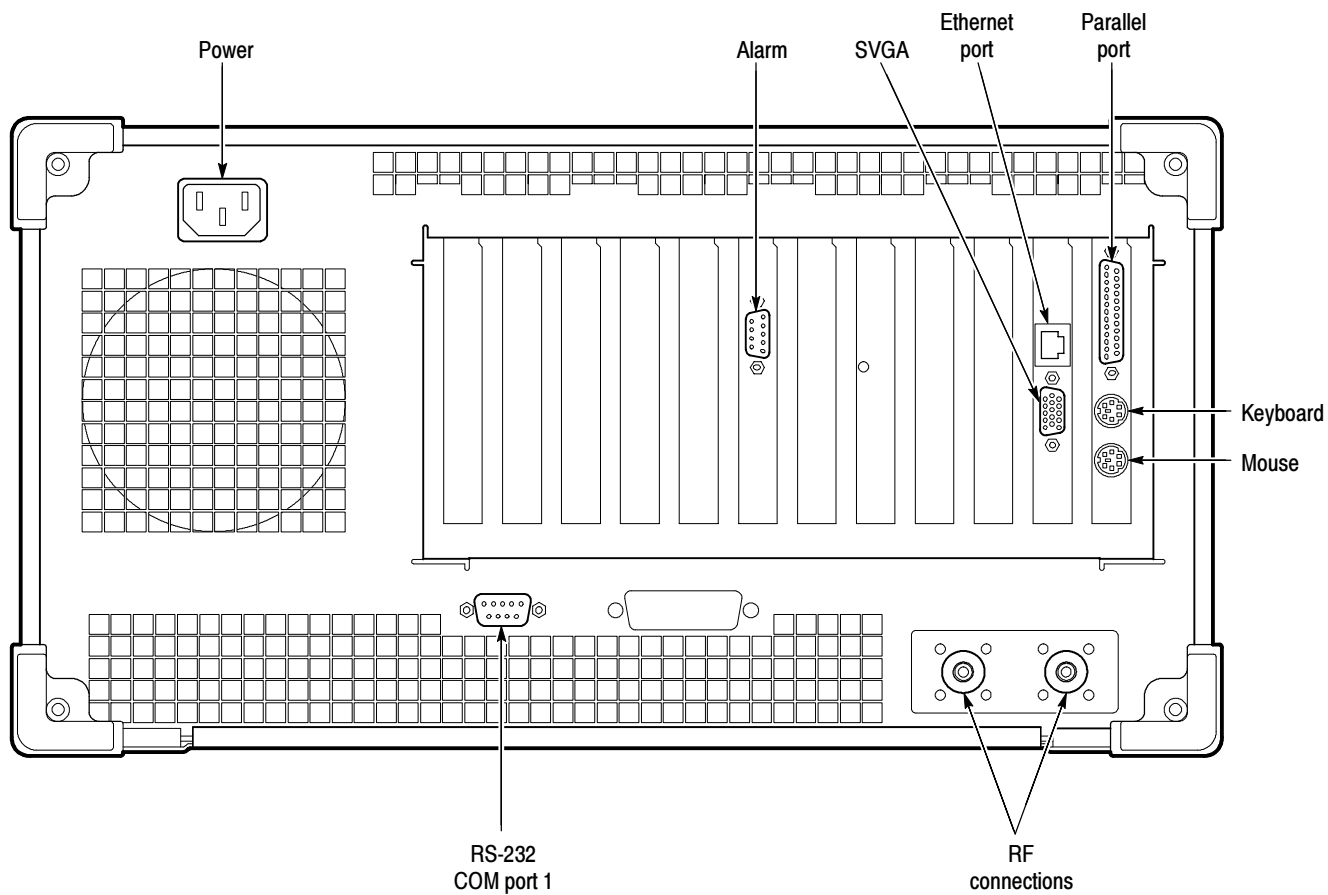


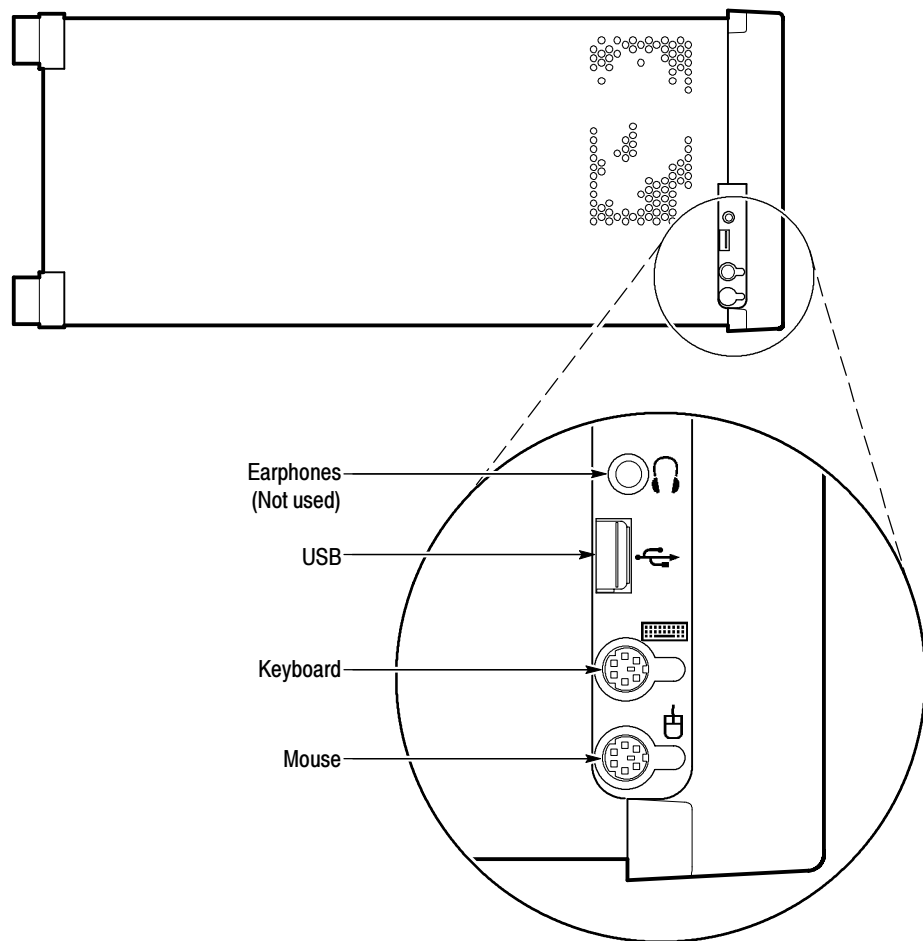
Figure 1-10: Rear view

## Interface Connections

The interface connectors on the rear and side of the RF measurement set, shown in Figure 1-10 and Figure 1-11, provide the interconnection ports for peripheral devices and networking. Pin assignments for the rear panel and side panel connectors are listed in Table A-4 and Table A-5 in *Appendix A: Specifications*.

## Keyboard and Mouse Connections

Connect the keyboard and mouse to the left side of the instrument as shown in Figure 1-11.



**Figure 1-11: Keyboard and mouse connections**

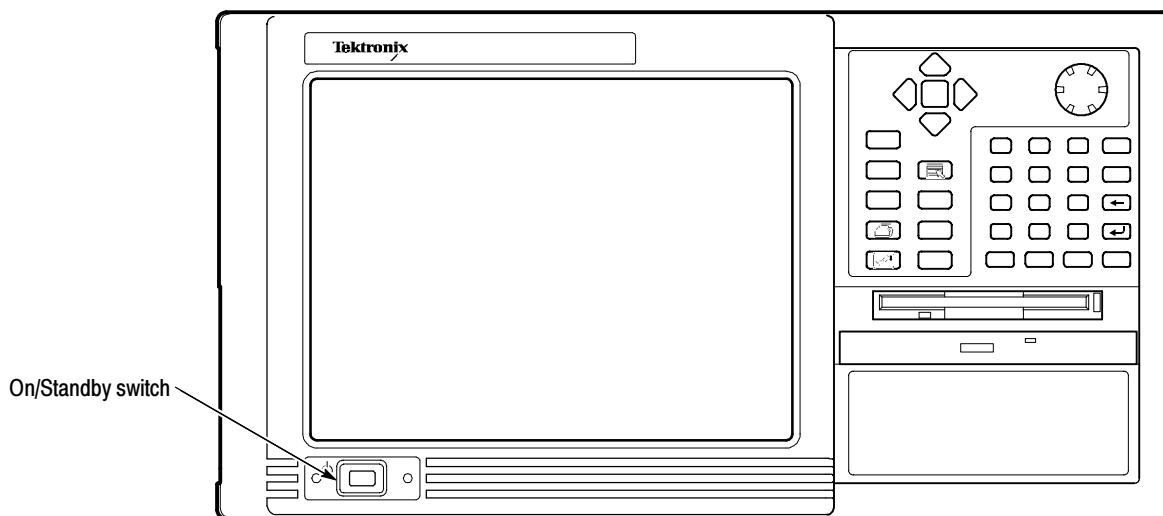
## Powering On and Off

This section contains the procedure for powering on the instrument for the first time. To power off the instrument, refer to *Powering off* on page 1-18.

### First Time Power On

Power on the measurement set as follows:

1. Press the On/Standby switch to power on the instrument (see Figure 1-12 for the switch location).



**Figure 1-12: On/Standby switch**

2. Wait for the instrument to complete power-on self-tests.

The screen displays an Enter Windows Password dialog box prompting you for a logon name and password. However, if a password is entered then each time you power on the measurement set you will be prompted for logon information. To avoid this, do the following steps:

- a. Enter a user name (for example, RFA300A) in the Enter Windows Password dialog box.
- b. Click OK, but do not enter a password.
- c. Click OK in the Set Windows Password dialog box, but do not enter a password.

3. Follow the instructions on the screen and enter the Windows NT Product Identification number (located above the bar code) on the Windows NT software package that came with your instrument. Enter other information as required.

The internal setup software automatically configures your instrument and installs all required devices. After the setup software completes configuration, the measurement set application will start.

The next time you power on, the application starts automatically. You do not need to perform step 3 again.

### Powering off

Always power off the instrument using the Windows NT shutdown process and then press the On/Standby switch.

---

**NOTE.** *Once a month, power down and restart the instrument. The measurement set performs an internal calibration as part of the power on procedure. This ensures the optimum measurement accuracy of the instrument.*

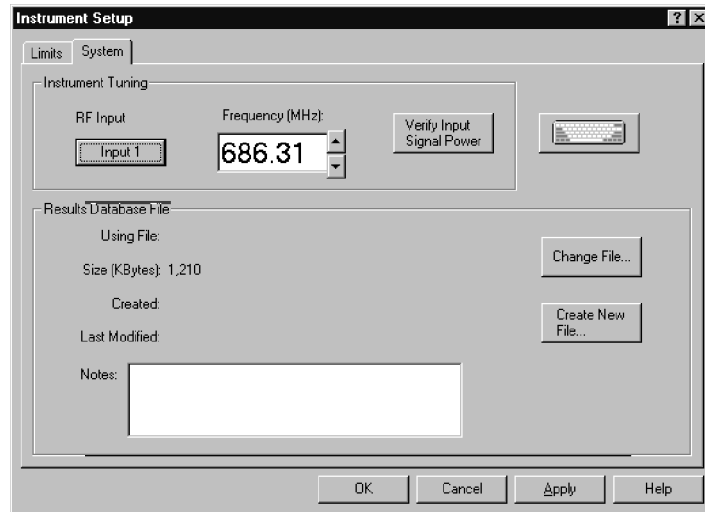
---

## Selecting RF Input Channel and Channel Frequency

Use the following procedure to select the RF Input channel, select the channel frequency, and verify that the RF input signal has sufficient power. Without sufficient power at the test signal input, the instrument cannot perform accurate measurements.

1. Connect your transmitter to one of the RF input connectors shown on page 1-15 (the connectors are internally terminated in 50  $\Omega$ , so no external termination is needed).
2. If the input signal strength is more than 1 watt (but no greater than 2 watts), make sure that the external 10 dB attenuator is installed.
3. Power on the instrument.
4. Click the Setup button on the toolbar.
5. Click on the System tab to display the System page (shown in Figure 1-13).





**Figure 1-13: System setup**

6. Click on the Input button to select the RF Input channel (Input 1 or Input 2) to which you connected the transmitter. Only one of these channels can be input at a time.
7. Enter the desired frequency.

---

**NOTE.** The frequency is the pilot frequency, not channel center. Refer to Selecting channel frequency in the online help.

---

8. Click Apply, and then click the Input Signal Power button.
9. Check to see if the RF input signal level is in the OK range; if it is not, then adjust the output of your transmitter accordingly.
10. Close the Input Signal Power dialog box and click OK to close the System Setup window.

## Incoming Inspection

Incoming inspection consists of verifying basic operation of the measurement set. The Power-on diagnostics check basic functionality. These diagnostics run every time you power on the instrument. If a failure is detected, the Power-on diagnostics dialog box opens with the failed test indicated.

### Extended Diagnostics

Run the extended diagnostics to test functionality in more detail. To run extended diagnostics, do the following procedure:

1. Go to the Tools menu and select Diagnostics.
2. Click the Extended Diagnostics tab.
3. Select All Modules and Tests and then select One Time.
4. Click Run and observe that a failure does not occur.

If a failure does occur, contact Tektronix using the information provided in the *Preface* of this manual or click on Support located under the Help menu.

### Signal Power

Perform the procedure on page 1-18 titled *Selecting Channel Frequency* and verify that the RF input signal has sufficient power and is connected to the selected RF input (1 or 2).

### Measurement Functionality

Open each measurement window and verify that activity is occurring. For example, to check Frequency Response and Group Delay do the following procedure:

1. From the Home window, click on the Frequency Response and Group Delay icon to open the measurement window.
2. Verify that a signal is visible in each waveform graphic within a few seconds.
3. Verify that the readout for both measurements is updating.

Perform the same procedure for each measurement.

# Operating Basics

This chapter describes the basic operation of the RFA300A Measurement Set 8VSB. For operating details, refer to the online help.

## Front Panel

The front panel controls are used to operate the measurement set without the mouse or keyboard. Figure 2-1 shows the front panel.

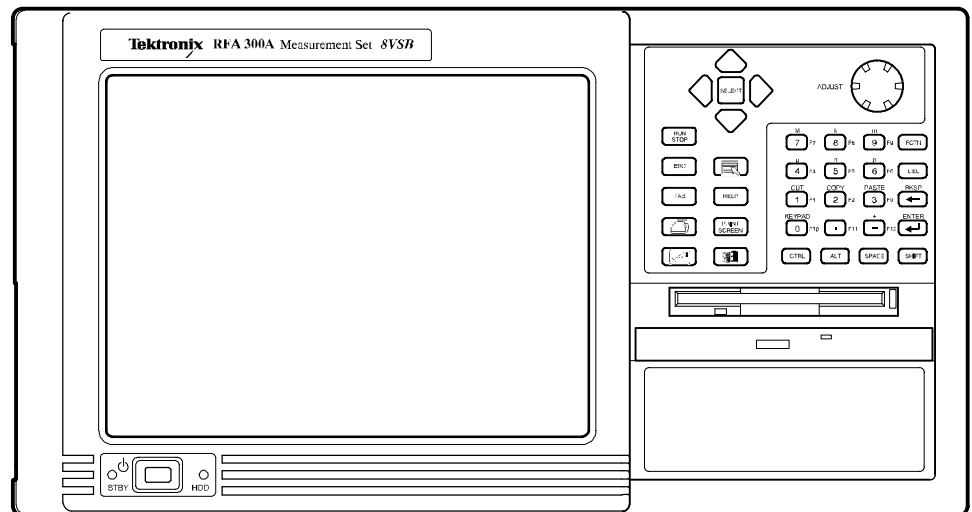


Figure 2-1: Front panel

**Keys** You can use the front panel keys as an alternative to a keyboard. All keys and key combinations critical to operating the instrument or for basic Windows tasks are available via the front panel. To enter letters of the alphabet or special characters, use the soft keyboard feature (refer to *Entering text from the screen* in the online help).

For key combinations, it is unnecessary to hold down more than one key at a time. For example, you can press SHIFT in the hex keypad, and then press another key to accomplish a Shift+key combination. The same is true for other key combinations, such as CTRL and ALT keys. This feature is often referred to as a locked mode.

Table 2-1 lists front-panel key controls and describes their use.

**Table 2- 1: Front panel-key controls**

Control name	Mechanism	Description
Up Arrow	Button	Use to navigate and change focus from one window function to another.
Left Arrow	Button	
Right Arrow	Button	
Down Arrow	Button	
Select	Button	Same as the space key.
Adjust Knob	Rotary encoder	Multi-function control, increment/decrement field values or screen element size or position.
Run/Stop	Button with 3-color LED	Starts or stops a measurement. LED indicates whether product is in Run or stop state.
Esc	Button	Standard Escape key.
Tab	Button	Standard Tab key.
Print	Button	Prints current measurement using the same print settings as for the previous print.
Touch	Button	Toggles Touch Screen state on and off. LEDs indicate Touch Screen On/Off state.
Menu (application key)	Button	Same as mouse button two.
Help	Button	Opens the Help contents. Standard F1 key
Print Screen	Button	Copies the screen to the clipboard. Alt plus Print Screen copies the active window.
START Key	Button	Opens the Windows Start menu.
Numbers 0 to 9, period and minus sign	Buttons	Standard number keys, most have second (Shift) and third (Function) functions.
Fctn	Button with LED	Modifier for numeral keys to create keys F1 through F12. Locked mode key feature. LED indicates when on.
Del	Button	Deletes selected text or object.
←	Button	Backspace key.
↵	Button	Enter key.
Ctrl	Button with LED	Control key. LED indicates when keypad is in control mode. Refer to Table 2-2 for a list of control functions. Locked mode key feature.
Alt	Button with LED	Alternate key. LED indicates when keypad is in alternate mode. Locked mode key feature.
Space	Button	Space bar or use as mouse button 1
Shift	Button with LED	Shift key. LED indicates when keypad is in shift mode. Locked mode key feature.

**Table 2-2: Control key combination functions**

Control key	Function
Ctrl+A	Invokes the AutoScale function
Ctrl+B	Opens the previous window (same as the toolbar<<Back)
Ctrl+C	COPY
Ctrl+F	Opens the following window (same as the toolbar Fwd >>)
Ctrl+H	Opens the Home window
Ctrl+K	Opens the Keypad dialog box
Ctrl+O	Opens the Recall Results dialog box
Ctrl+P	Prints the measurement
Ctrl+S	Saves the results of the current measurement
Ctrl+T	Toggles the Touchscreen on or off
Ctrl+V	PASTE
Ctrl+X	CUT
Ctrl+Y	REPEAT
Ctrl+Z	UNDO

**Touch Screen** The touch screen allows you to use your finger instead of a mouse. Move your finger around the screen to move the cursor. Tap to select an object and select ENTER to activate the object.

**Soft Keyboard** You can use the soft keyboard with any application. To display the soft keyboard, select **My-T-Soft** from the Program menu, click the keyboard icon in the System Setup menu, or click a keyboard icon displayed in an application.

You can configure the keyboard (change the size, for example). To do this, click the icon shaped like a hand in the upper right corner of the keyboard display to access a dialog box.

**Tutorial.** For a tutorial on how to use the soft keyboard, select **My-T-Soft Welcome** from the My-T-Soft program group (in Programs in the Windows startup menu).

**Licensing.** If the RFA300A software is correctly installed the first time you use the soft keyboard, the My-T-Soft keyboard registers itself. If the RFA300A is not installed, the My-T-Soft keyboard will be loaded as a demo version. To undo this, uninstall the My-T-Soft keyboard, properly install the RFA300A software, and then reinstall the keyboard.

To display the license status, select **Licensing** from the My-T-Soft program group (from Programs in the Start Up menu).

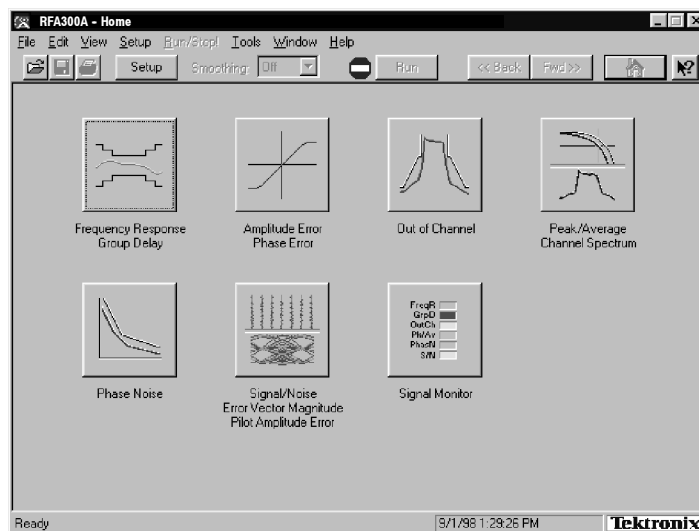
---

**NOTE.** *The My-T-Soft keyboard must be installed on the same drive letter as the RFA300A software.*

---

## Home Window

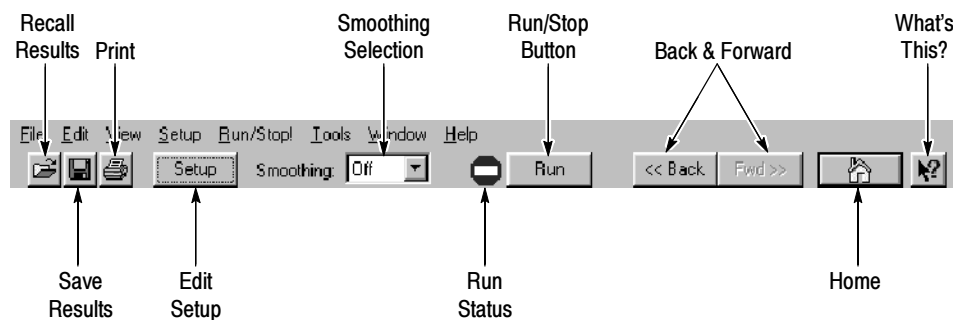
The Home Window is the point-of-entry into the measurement set. From the home window, you access all measurements by clicking on the appropriate icon. A measurement begins to run immediately when the window opens. Figure 2-2 shows the Home window. Refer to the *Reference* chapter for an overview of each measurement window.



**Figure 2-2: Home window**

**Menus** Menu selections are available from any measurement window and the Signal Monitor window. Refer to the online help for a description of each menu selection.

**Toolbar** All toolbar selections are available from any measurement window and the Signal Monitor window. The toolbar provides an easy method for accessing frequently-used functions. Figure 2-3 shows the toolbar and Table 2-3 lists the toolbar functions.



**Figure 2-3: Toolbar**

**Table 2-3: Toolbar functions**

Toolbar selection	Function
Recall Results	Recalls a previously saved measurement.
Save Results	Save the results of the current measurement.
Print	Prints one copy of the current measurement.
Edit Setup	Provides setup controls for the instrument and measurements.
Smoothing Selection	Selects the degree for reducing the variations of the waveform and results. Smoothing is accomplished differently for each type of measurement. Refer to the online help for each measurement window to determine how smoothing is accomplished.
Run Status	Shows when the measurement is running or stopped. Red is stopped and green is running.
Run/Stop Button	Begins or stops performing measurements.
Back and Forward	Back opens the previously opened window. Forward opens the following window.
Home	Returns to the Home window.
What's This?	Provides a brief description of the selected control or object.

## Making a Measurement

The following provides a basic overview of how to make and save a measurement. Refer to the online help for details on other operating features. An explanation of how help works is on page 2-9.

### Selecting Frequency

Before running measurements you must select your channel frequency and determine that the input signal has power within the correct range. Refer to *Selecting RF Input Channel and Channel Frequency* on page 1-18 for the procedures on selecting channel frequency and checking input signal power.

### Limits Versus Masks

Before proceeding, you should understand the differences between limits and masks. Limits are parameters against which numeric measurement results can be compared automatically. You can choose the color to highlight results that violate parameters.

The mask-testing feature allows you to set visual parameters within the graphic portion of the measurement window. The masks are lines against which you can compare waveforms.

### Limits

After selecting your channel frequency and checking input signal power, you can edit caution and alarm limits. The instrument compares each new result against the current limits as soon as you enter the measurement window. To edit limits, do the following:

1. Click the Setup button located in the toolbar.
2. Click the Limits tab.
3. Select which results are to be compared against the limits when the measurement is running.
4. Enter the low value for Alarm. The value must be less than the low Caution value.
5. Enter the low value for Caution. The value must be less than High Caution and greater than Low Alarm.
6. Enter the high value for Caution. The value must be less than High Alarm and greater than Low Caution.
7. Enter the high value for Alarm. The value must be greater than High Caution.

For some measurements, you cannot enter values for all limits because it would be counter productive. For example, there is no reason to set a high caution or alarm value for signal-to-noise when you want the signal-to-noise ratio to be as high as possible.



- Masks** The mask-testing feature is not on when you receive your measurement set. To turn masks on and off or to select different masks, do the following:
1. Open a measurement window. For example, open the Amplitude and Phase Error window.
  2. Click the Setup button located in the toolbar.
  3. Select the appropriate box to enable a mask test. The mask is enabled when checked.
  4. Select the mask you want to use.
  5. Click OK to accept your changes and return to your measurement window.

Not all of the measurements need or include a mask test. Those that do not are the Signal/Noise, Error Vector Magnitude, and Pilot Amplitude Error window and Peak/Average and Channel Spectrum window.

You can create a mask for those measurements that include mask testing. Refer to *Mask file formatting* in the online help.

- Viewing Results** Once you open a measurement window, notice that the measurement runs and provides results soon after the window opens. To stop the measurement, press the Stop button located in the toolbar. To restart, press the Run button.

- Saving Results** After making a measurement, you can save your results to a database by doing the following:

1. Go to the File menu and select Save Results As.
2. Enter name, destination, and any notes you want saved with the results.

Results can be printed or exported to other applications using the Report dialog box selected in the File menu. You can also recall results for further study at any time.

- Signal Monitor** The Signal Monitor allows you to continuously monitor one or more of the other measurement's numeric results in one window. To select the measurements to monitor, do the following:

1. Open the Signal Monitor window.
2. Click Setup in the Toolbar.
3. Select the measurements you want to monitor.
4. Select how often you want your results to be automatically saved or select Off to disable the function.

5. If you selected At Intervals in step 4, enter the amount of hours to save between AutoSave actions.

---

**NOTE.** *An indication of how long the instrument can run before running out of space is provided. Click the File Size button to limit the size of your result database files. Refer to Limiting the size of a results database file in the online help.*

---

6. Select when to be notified (under Notification Criteria) if a caution, alarm, or error occurs. You can also select not to be notified.
7. If you selected to be notified in step 6, select the notification action.

---

**NOTE.** *Before you can set up Email notification, you must install a Messaging Application Program Interface (MAPI) compliant Email application.*

---

8. Click the **Email Settings** button to change Email parameters.

---

**NOTE.** *Selecting Send Email opens the Email dialog box if the destination is not yet specified. You can enter the address, include a message, and send the current results or only results that have violated limits.*

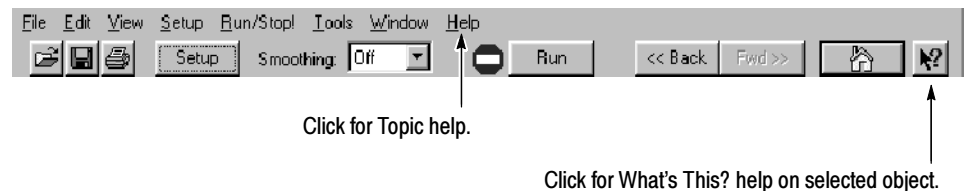
---

9. Click **Suspend Actions** and select how often you want to be notified.
10. Click **OK** to close.
11. Click the Setup's **OK** button to apply your selections and return to the Signal Monitor window.

## Online Help

The online help gives detailed information about the operation of the measurement set. Look in the online help for details about user selections and controls that are not described in this manual.

To access online help, go to the Help menu as shown in Figure 2-4.



**Figure 2-4: Help menu**

### Help Topics

Help topics tell you how to perform tasks and describe software features and selections shown on the screen. There are two types of help topics, reference topics and task topics.

Reference topics describe application features, such as the measurement windows. Reference topics may also describe concepts. Reference topics are available through the Help menu and through Help buttons in dialog boxes. From the Help menu, click Help Topics, and locate the topic using the Contents or Index tab. The Index tab is easier to use. As you enter a word into the text field, Help searches for and highlights the topic if one can be found. If not, try the Find tab. Enter a word or phrase and help will display all topics that contain the word or phrase. The Help on Window selection in the Help menu provides reference help for the current window.

Task topics provide procedure information on how to perform specific tasks. Task topics are available through the Help menu. From the Help menu, click Help Topics, and locate the topic using the Contents or Index tab.

### What's This? Help

What's This? help provides a short description of the control or screen feature selected. First, click the What's This? button on the toolbar as shown in Figure 2-4, and then click the item of interest.

### **Windows NT Online Help**

Information about Windows features is available through the Windows help system. Access Windows help as you would with any Windows application:

1. Go to the Windows taskbar and click Start.
2. Select Help from the popup menu.

---

**NOTE.** *To access Windows NT help using the Touchscreen, press the START key on the front panel.*

---

### **Release Notes**

The online Release Notes contain information about this release of the RFA300A application. Check the Release Notes for information such as software compatibility and software version differences from last release.

To access the Release Notes, go to the Windows NT taskbar and click Start, or press the front panel START key. The Release Notes are at the top of the Start menu.

## **Backing Up Files**

You should back up your files on a regular basis. Use the Windows Back Up tool to back up files stored on the hard disk. The Back Up tool is located in the following path: Programs\Accessories\System Tools\Back. Start the tool and determine which files and folders you want to back up. Use the Windows online help for information on using the Back Up tool.

In particular, you should back up your user-generated masks, setup files, and the results database files.

# Reference

This section gives an overview of each measurement within the measurement set and the 8VSB transmitter.

## Out of Channel Emissions

This section provides an overview of the Out of Channel Emissions measurement window. For more in-depth information, refer to the online help.

Out of Channel Emissions is a vital measurement that is specified by the FCC. To prevent interference outside of the allotted spectrum, the RF signal must comply with the specified mask for the transmitter under test.

---

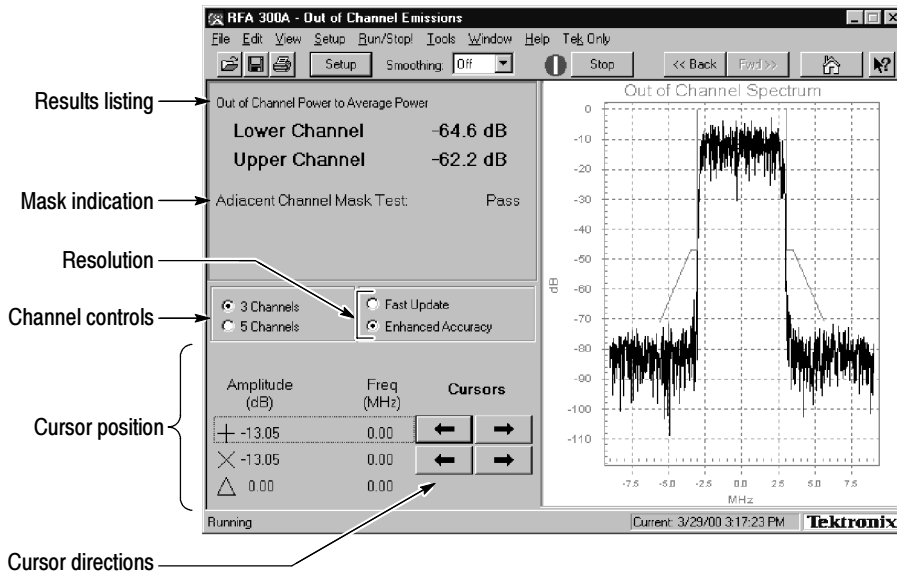
**NOTE.** *The measurement set is limited to measurements between 0 and -80 dB on the FCC's scale.*

---

The measurement set performs the measurement by calculating the power of the signal that passed through an  $\approx 30$  kHz filter before being digitized. The measured values are adjusted to an equivalent 500 kHz noise bandwidth and divided by the total transmitter output power. This is the FCC measurement method.

The Out of Channel Emissions measurement window is shown in Figure 3-1. The measurement window contains the following areas:

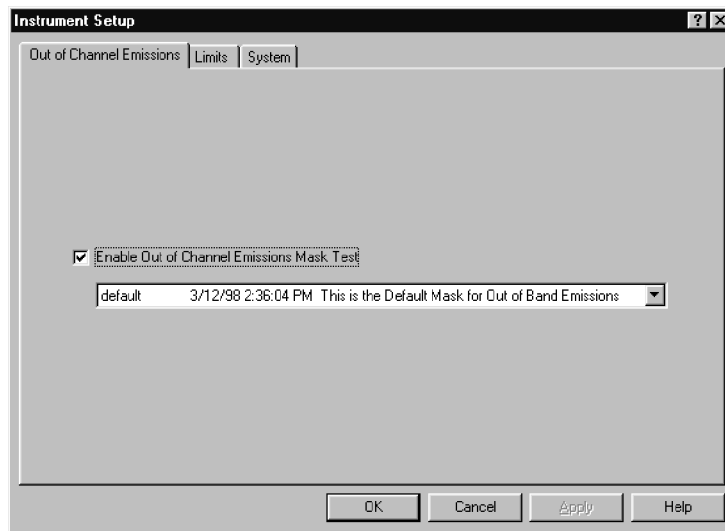
- A listing of measurement results.
- A mask test pass or fail indicator.
- Controls for selecting the number of channels to display.
- Controls for resolution.
- Cursor direction controls.
- A listing of each cursor's position and the difference between the two.
- Graphic showing the spectral waveform with the selected mask overlaid on the spectrum display, if enabled from the setup (refer to *Out of Channel Emissions Setup* next).



**Figure 3- 1: Out of Channel Emissions measurement window**

**Out of Channel Emissions Setup**

Click the Setup button in the toolbar to enable mask testing and select a mask for the measurement window. The setup dialog box contains the control for turning masks on and off, plus a list of available masks. You can create your own mask and place it into the measurement set for use. Refer to *Appendix D: Mask File Formatting* in this manual for detailed instructions. Figure 3-2 shows the Out of Channel Emissions setup.



**Figure 3- 2: Out of Channel Emissions setup**

## S/N, EVM, and Pilot Amplitude Error

This section provides a brief overview of the Signal-to-Noise, Error Vector Measurement, and Pilot Amplitude Measurement window. For more in-depth information, refer to the online help.

The S/N, EVM, and Pilot Amplitude Error measurement window provides an overview of the transmitter's 8VSB signal quality. Signal-to-Noise (S/N), Error Vector Magnitude (EVM), and Complex Modulation Error Ratio (MER) are similar measurements. The calculations for each are slight deviations from each other. Refer to S/N, EVM, and Complex MER calculations in the online help.

Figure 3-3 shows the measurement window with the constellation display. The window contains the following areas:

- A listing of measurement results.
- Two display graphics: constellation and eye diagram.
- A control for turning equalization on and off. Equalization removes linear distortions from the measurements. This allows you to distinguish among causes of poor signal quality.
- A control for subtracting the pilot amplitude from the horizontal axis.

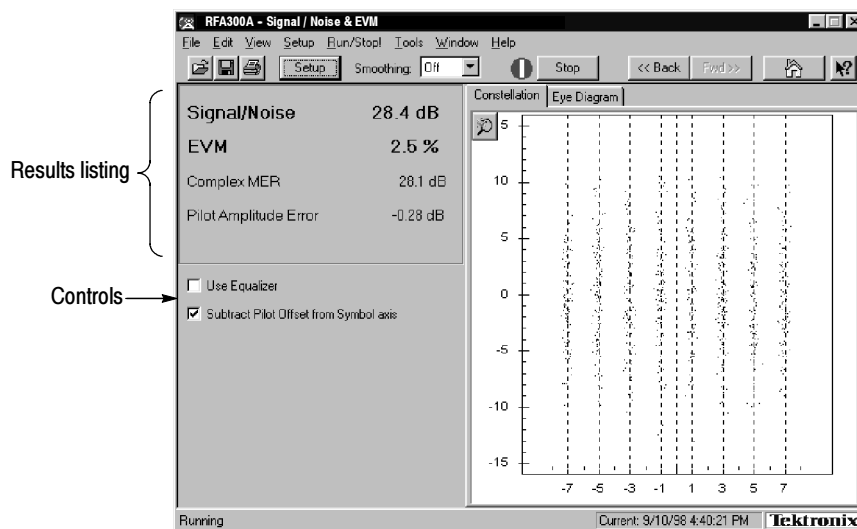


Figure 3-3: S/N, EVM, and Pilot Amplitude measurement window

**S/N** The S/N measurement provides a broad measure of impairments in the transmitted signal. S/N is the power ratio between the ideal received signal and the difference between the ideal and actual received signal as measured along the real axis during symbol times only. A comparison is made between the deviation

of the actual digitally modulated television signal and an ideal signal of the same data. This measurement is the major all-in-one indicator of the transmitter's signal quality. The test is an early indication of system problems before they become bit errors and is more sensitive to modulation errors than Bit Error Ratio (BER) tests.

**EVM** The EVM (Error Vector Magnitude) measurement also provides a broad analysis of the transmitted signal. EVM analysis can reveal incorrect filter shaping (see *VSB Modulation* on page 3-18) and other modulation quality problems.

**Complex MER** Complex MER is a complex form of S/N. The measurement is made by including Q (quadrature) channel information into the calculation. Refer to Complex MER calculation in the online help.

**Pilot Amplitude Error** This measurement shows any error of the pilot signal amplitude.

## Phase Noise

This section provides a brief overview of the Phase Noise measurement window. For more in-depth information, refer to the online help.

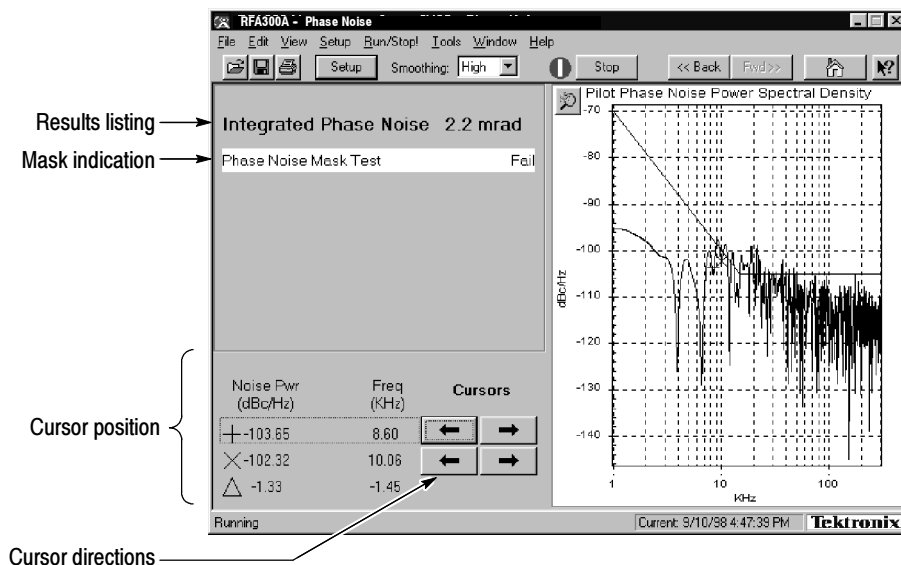
This measurement window measures the random low frequency phase deviations of the entire 8VSB signal. Phase noise is typically added by the transmitter's frequency synthesizer system. Phase noise can reduce the S/N ratio.

The measurement set performs this measurement by calculating the residual phase jitter. This jitter is what is left after removing the effects of other transmission errors.

The Phase Noise measurement window is shown in Figure 3-4. The measurement window contains the following areas:

- Listing of measurement results
- A mask test pass or fail indicator
- Cursor direction controls
- Listing of each cursor's position and the difference between the two
- Graphic showing the pilot's phase noise spectral density measured in dBc/Hz versus frequency. The selected mask is overlaid on the display, if you enabled any in the setup (see *Phase Noise Setup* next).

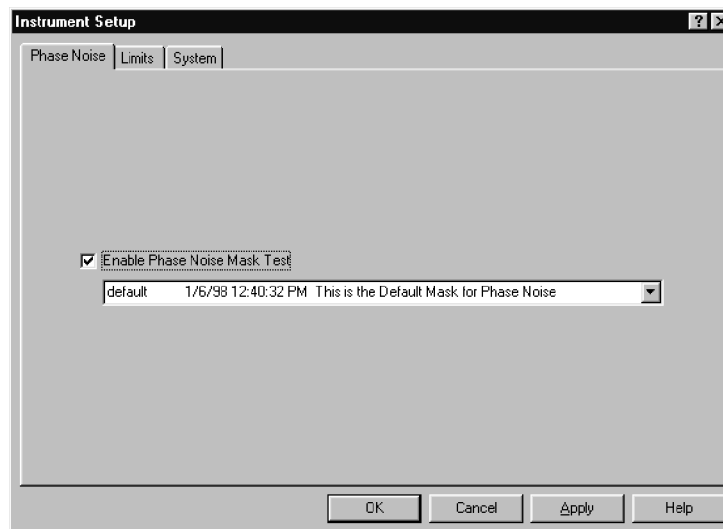




**Figure 3-4: Phase Noise Measurement window**

### Phase Noise Setup

Click the Setup button in the toolbar to enable and select a mask for the measurement window. The setup dialog box contains the control for turning masks on and off, plus a list of available masks. You can create your own mask and place it into the measurement set for use. Refer to *Appendix D: Mask File Formatting* in this manual for detailed instructions. Figure 3-5 shows the Phase Noise setup.



**Figure 3-5: Phase Noise setup**

## Frequency Response and Group Delay

This section provides a brief overview of the Frequency Response and Group Delay measurement window. For more in-depth information, refer to the online help.

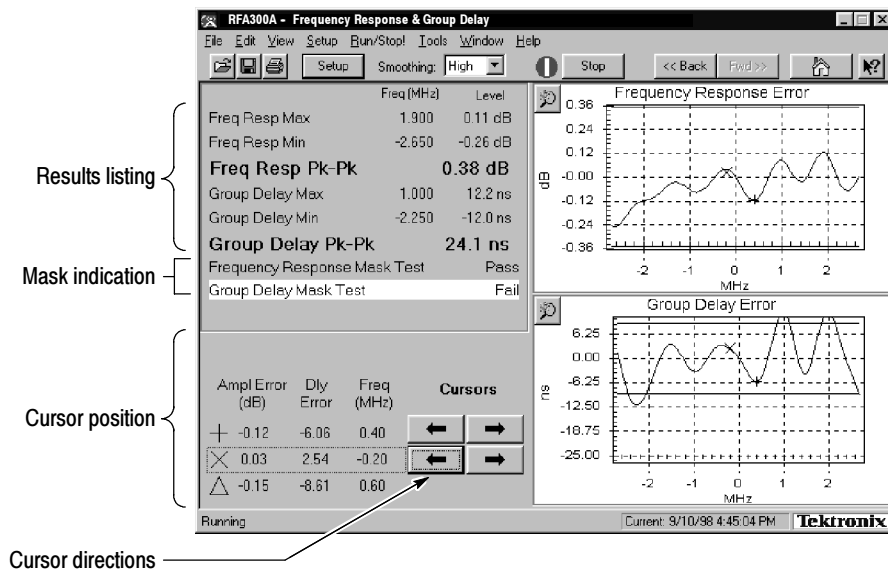
This measurement measures frequency response and group delay errors. These errors are the result of linear distortion caused by transmitter imperfections or possibly small impedance mismatches or both.

The frequency response errors are listed in dB. The frequency at which the minimum and maximum errors were found is also shown. Group delay errors are in nanoseconds.

The measurement set calculates these measurements by deriving the amplitude and time delay response of the channel from the equalizer tap coefficients. Frequency response and group delay are calculated relative to the pilot frequency or the center of the channel as selected in the setup.

The Frequency Response and Group Delay measurement window is shown in Figure 3-6. The measurement window contains the following areas:

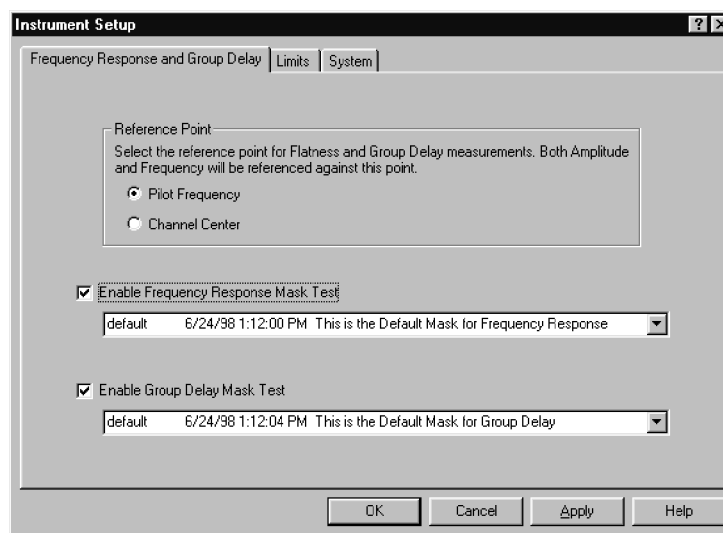
- A listing of measurement results.
- Cursor direction controls.
- A mask pass or fail indicator for each measurement.
- A listing of each cursor's position and the difference between the two.
- Graphics showing frequency response measured in dB versus frequency and group delay measured in time (nanoseconds) versus frequency. Selected masks are overlaid on the display, if you enabled any in the setup (refer to *Frequency Response and Group Delay Setup* next).



**Figure 3-6: Frequency Response and Group Delay measurement window**

## Frequency Response and Group Delay Setup

Click the Setup button in the toolbar to enable and select a mask for each measurement in the measurement window. In addition, the setup has a reference point selection for the measurements: either channel center or the pilot. The setup contains the control for turning masks on and off, plus a list of available masks. You can create your own mask and place it into the measurement set for use. Refer to *Appendix D: Mask File Formatting* in this manual for detailed instructions. Figure 3-7 shows the Frequency Response and Group Delay setup.



**Figure 3-7: Frequency Response and Group Delay setup**

## Amplitude and Phase Errors

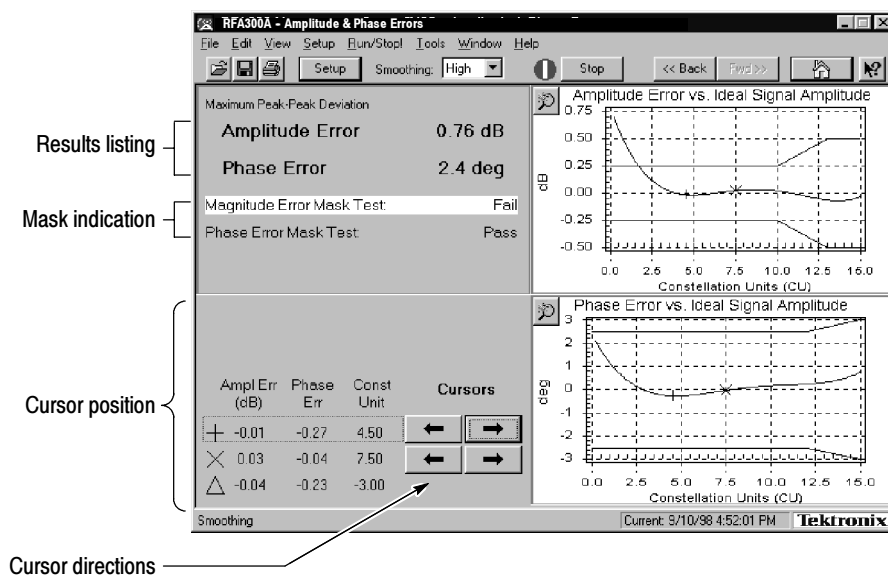
This section provides a brief overview of the Amplitude and Phase Errors measurement window. For more in-depth information, refer to the online help.

This measurement measures amplitude and phase errors, which are nonlinear distortions. A signal's phase can shift with amplitude. Transmitters, particularly high power ones, can exhibit amplitude errors in the form of clipping or compression when close to full power. These errors decrease a transmitter's Signal-to-Noise ratio, thereby reducing the coverage area.

The measurement set performs the measurement by calculating ideal signal magnitude and phase from the received I/Q signal and comparing it with the actual signal.

The Amplitude and Phase Errors measurement window is shown in Figure 3-8. The measurement window contains the following areas:

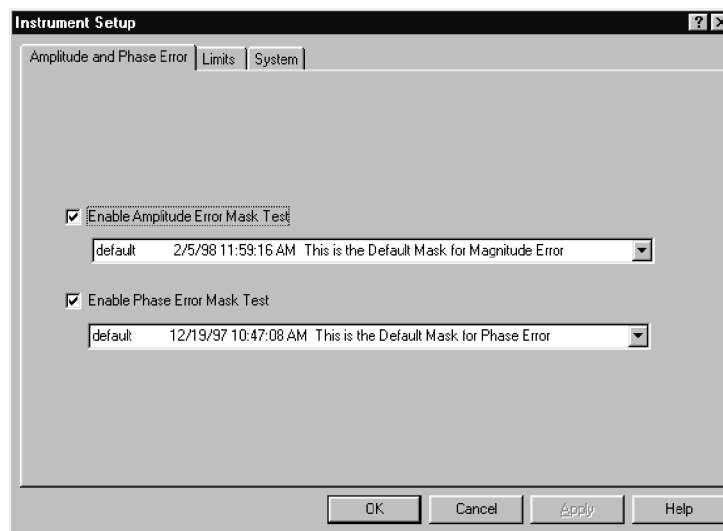
- A listing of measurement results.
- A mask test pass or fail indicator for each measurement.
- Cursor direction controls.
- A listing of each cursor's position and the difference between the two.
- Graphics showing signal amplitude error versus ideal signal amplitude measured in dB versus constellation units (refer to the *Glossary*) and signal phase errors versus ideal signal amplitude measured in degrees versus constellation units. The selected masks are overlaid on the graphics, if enabled from the setup (refer to *Amplitude and Phase Errors Setup* next).



**Figure 3-8: Amplitude and Phase Errors measurement window**

### Amplitude and Phase Errors Setup

Click the Setup button in the toolbar to enable and select masks for the measurement window. The Setup dialog box contains controls for turning masks on and off and selections for using different masks. You can create your own mask and place it into the measurement set for use. Refer to *Appendix D: Mask File Formatting* in this manual for detailed instructions. Figure 3-9 shows the Amplitude and Phase Errors setup.



**Figure 3-9: Amplitude Error and Phase Error setup**

## Peak-to-Average and Channel Spectrum

This section provides a brief overview of the Peak-to-Average and Channel Spectrum measurement window. For more in-depth information, refer to the online help.

This window measures the cumulative distribution of peak power over time. Peak power is the maximum value of envelope power that is randomly reached by the digitally modulated signal. Power amplifiers driven beyond their capability cause compression of peaks. This distorts the signal causing out of channel emissions and lower signal-to-noise ratio.

The measurement is calculated by taking the percentage of time that the signal is greater than the average amplitude. This measurement and the ideal are both plotted on the Peak-to-Average graph.

The Peak-to-Average and Channel Spectrum measurement window is shown in Figure 3-10. The measurement window contains the following areas:

- Listing of measurement results.
- A selection control for setting the target operating point in the peak-to-average graphic. Select the target operating point method in the setup (refer to *Peak-to-Average Setup* next).
- Graphics showing the measured and ideal peak-to-average power curves and the channel spectrum. The channel spectrum is another tool to assess a transmitter's amplitude linearity. To view this graph, click on the Channel Spectrum tab.

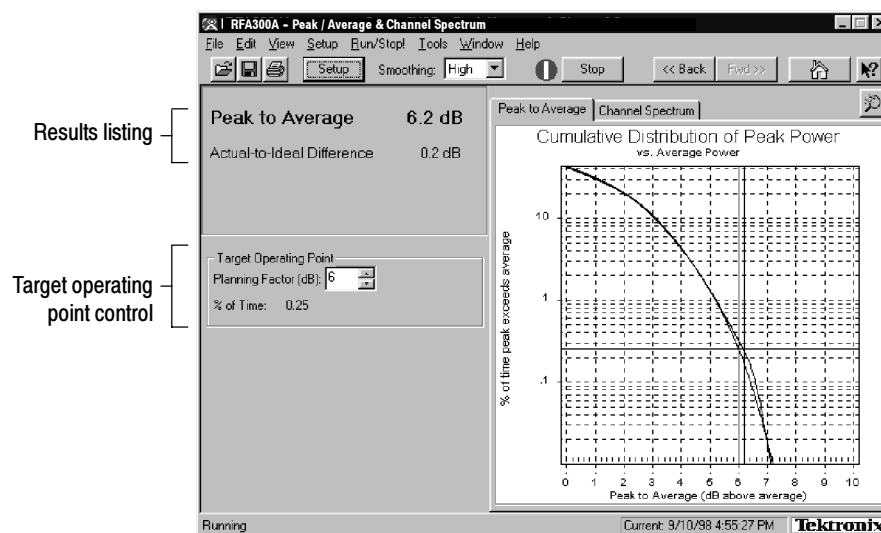
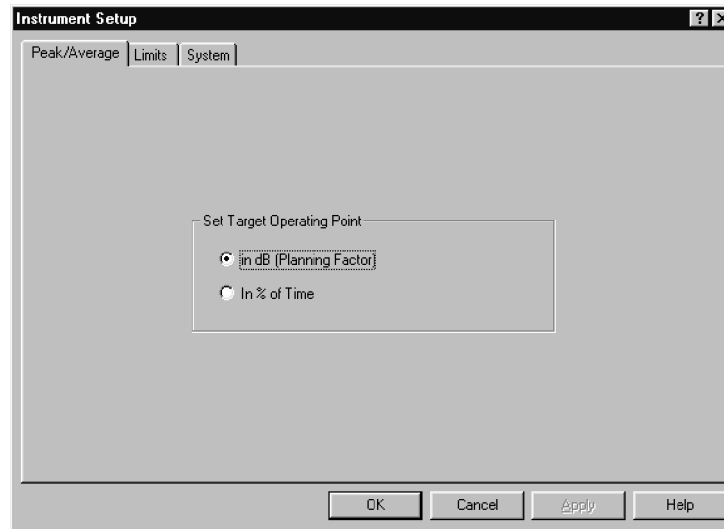


Figure 3-10: Peak-to-Average and Channel Spectrum measurement window

**Peak-to-Average Setup**

Click the Setup button in the toolbar to select the target operating point method for the measurement window. You can select in dB or percentage of time. Figure 3-11 shows the Peak-to-Average Setup.



**Figure 3- 11: Peak-to-Average Setup**

## Signal Monitor

This section provides a brief overview of the Signal Monitor measurement window. For more in-depth information, refer to the online help.

The Signal Monitor allows you to continuously monitor one or more of the other measurements in one window while the instrument is unattended. You can enter the setup for each measurement in each measurement's Setup dialog box. Set all cautions and alarms in the Limits dialog box (refer to *Limits* on page 2-6). The selection of which measurements to monitor is made in the Signal Monitor Setup. Figure 3-12 shows the Signal Monitor measurement window.

Test Name	Result	Time stamp	System Notes	Status
<b>Frequency Response &amp; Group Delay</b>				
Freq Resp Max	0.35 dB	9/2/98 1:21:28 PM		
Freq Resp Min	-0.02 dB	9/2/98 1:21:28 PM		
Freq Resp Pk-Pk	0.37 dB	9/2/98 1:21:28 PM		
Freq@Freq Resp Max	178.650 MHz	9/2/98 1:21:28 PM		
Freq@Freq Resp Min	174.150 MHz	9/2/98 1:21:28 PM		
Freq@Group Delay Max	177.700 MHz	9/2/98 1:21:28 PM		
Freq@Group Delay Min	179.380 MHz	9/2/98 1:21:28 PM		
Frequency Response Mask Test	Pass	9/2/98 1:21:28 PM		
Group Delay Mask Test	Pass	9/2/98 1:21:28 PM		
Group Delay Max	7.9 ns	9/2/98 1:21:28 PM		
Group Delay Min	-20.5 ns	9/2/98 1:21:28 PM		
Group Delay Pk-Pk	28.4 ns	9/2/98 1:21:28 PM		
<b>Amplitude &amp; Phase Errors</b>				
Amplitude Error Mask Test	Fail	9/2/98 1:18:55 PM		!
Amplitude Error Pk-Pk	0.95 dB	9/2/98 1:18:55 PM		?
Phase Error Mask Test	Pass	9/2/98 1:18:55 PM		
Phase Error Pk-Pk	1.5 deg	9/2/98 1:18:55 PM		
<b>Out of Channel Emissions</b>				
Out Chnl Pwr to Avg Pwr - Lower	-62.8 dB	9/2/98 1:19:02 PM		
Out Chnl Pwr to Avg Pwr - Upper	-62.8 dB	9/2/98 1:19:02 PM		
Out of Channel Mask Test	Fail	9/2/98 1:19:02 PM		!

**Figure 3-12: Signal Monitor measurement window**

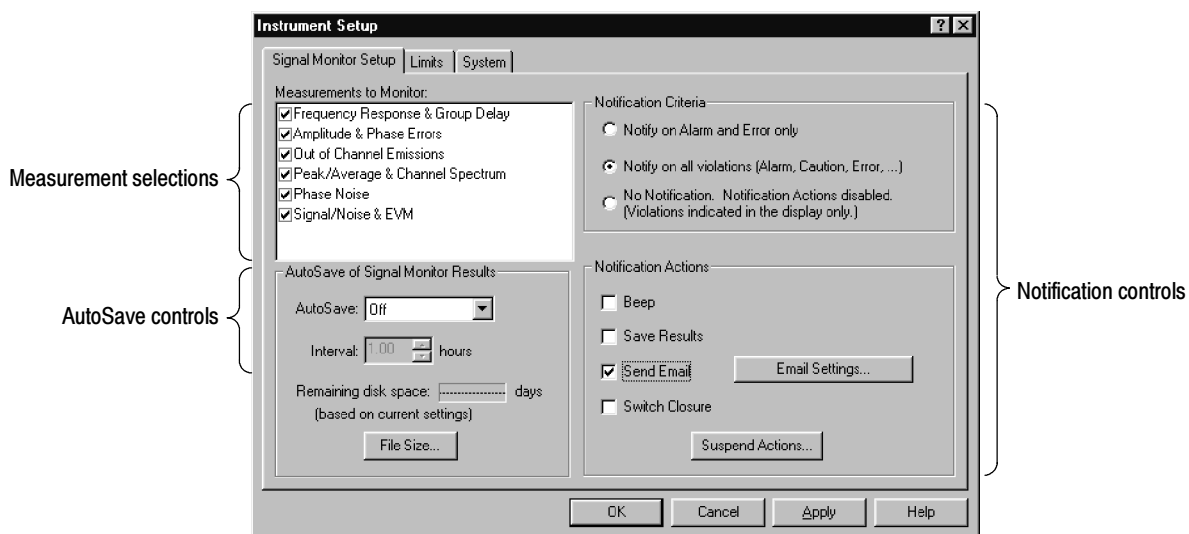


## Signal Monitor Setup

In addition to selecting measurements to monitor, you can also select the following in the Signal Monitor Setup:

- How often to save your results automatically, if at all.
- Size limit for the results database file.
- When and how to be notified of caution, alarm, and error conditions. Choices of how to be notified include sound, saving results, email, and by activation of an external device (see Figure 1-10 on page 1-15 for the alarm connection location).
- How often or when to be notified.

Figure 3-13 shows the Signal Monitor Setup.

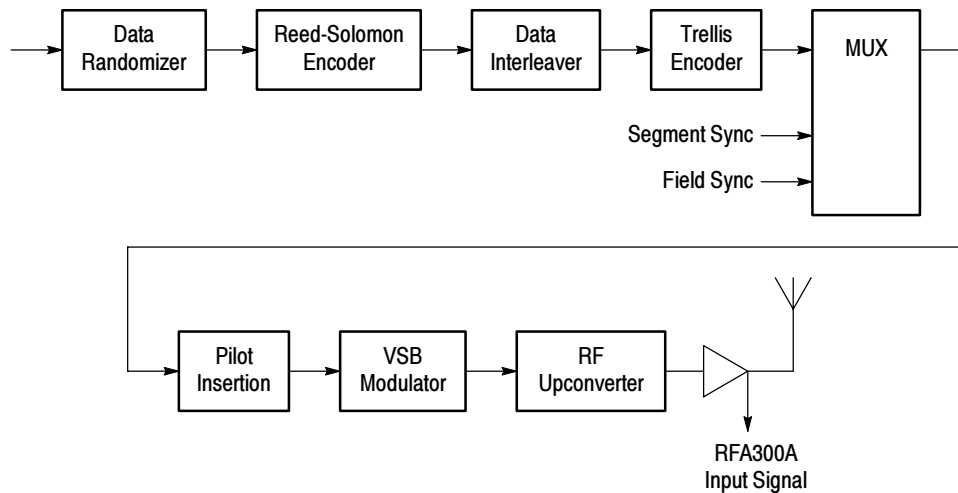


**Figure 3-13: Signal Monitor Setup**

## 8VSB Overview

This section provides an overview of the 8VSB transmitter. For a complete understanding of the transmitter, refer to Advanced Television Systems Committee (ATSC) Digital Television Standard document A/53. This document is available from the World Wide Web at <ftp://atsc.org/pub/Standards>.

The 8VSB standard is a RF modulation format used to broadcast Digital Television (DTV) to the home. This format was proposed by the ATSC and adopted by the FCC. The 8VSB transmitter generates the 8VSB signal as shown in Figure 3-14. The transmitter must take the bit-stream output from a MPEG II encoder and transmit it on a 6 MHz RF channel.



**Figure 3-14: 8VSB exciter block diagram**

### Data Randomizer

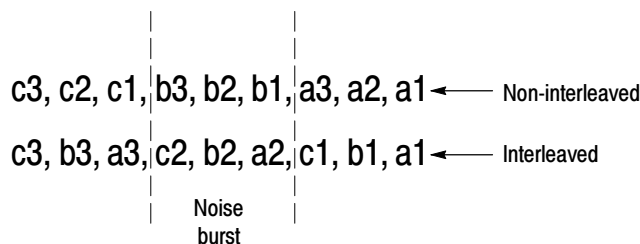
To use the 6 MHz channel space with maximum efficiency, the 8VSB bit stream must be randomized with a pseudo-random bitstream. This ensures a flat noise-like spectrum and reduces interference to NTSC channels. A recurring rhythmic pattern causes the RF energy content to cluster at certain areas in the frequency spectrum. Therefore, without additional processing, certain parts of the 6 MHz channel could be overused, while other areas are underused. The Data Randomizer changes each byte value to a known pseudo-random binary sequence (PRBS). The PRBS process is reversed in the television receiver to recover the correct data value.

### Reed-Solomon Encoder

The Reed-Solomon (RS) encoder uses Forward Error Correction (FEC) to correct received bit errors that can occur during transmission. The RS encoder takes the 187-byte data block and adds 20 parity bytes. The receiver compares the 187-byte block to the 20 parity bytes to determine if the data is valid. RS encoding can correct up to 10 byte errors per one 187-byte data block (packet).

**Data Interleaver**

Some noise burst durations are longer than the RS encoder can manage. For further protection, a time diversity scheme called data interleaving is used. Refer to Figure 3-15.



**Figure 3-15: Data interleaving**

A noise burst could delete all the b bytes of a non-interleaved signal resulting in a loss that the RS decoder in a receiver cannot recover. However, if the data is interleaved, only one byte is lost in each of the a, b and c byte segments of the interleaved signal. This leaves enough data for the decoder to determine the correct value. In reality, 8VSB data is interleaved to a depth of 52. This allows the decoder to determine the correct value of data that has been damaged by a 193  $\mu$ s noise burst.

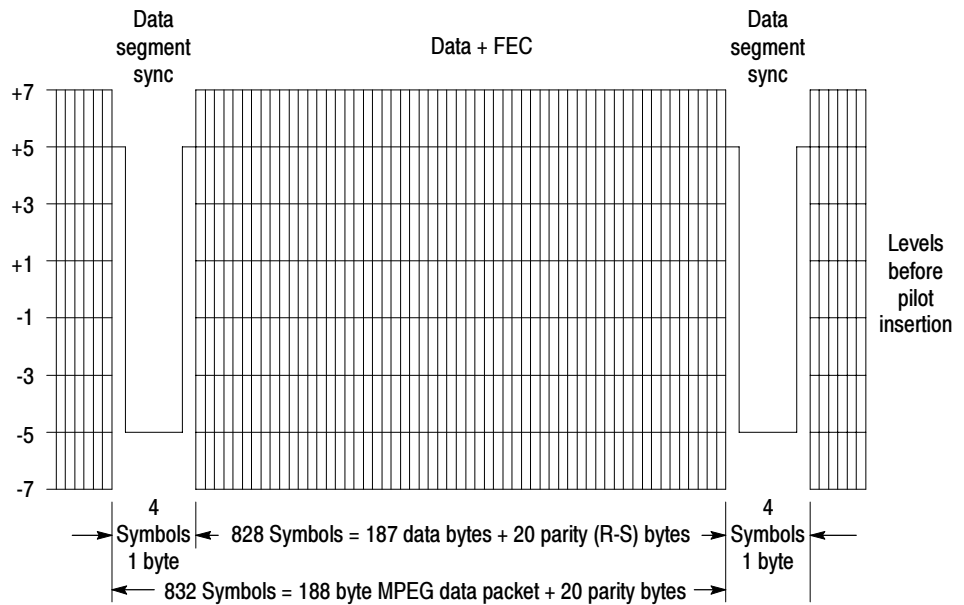
**Trellis Encoder**

A Trellis Encoder is another Forward Error Correction method. However, where as the RS encoder dealt with the entire data packet as a block, the Trellis encoder affects the stream of bits as they develop through time. Trellis encoding is accomplished by Trellis-Coded Modulation (TCM). TCM is a combination of coding and modulation that does not require additional bandwidth expansion although there are extra bits for FEC.

The Trellis encoder takes an eight-bit byte and splits it into four two-bit words. Every two-bit word is compared with previous words. A three-bit code is assigned to each two-bit word that describes the transition from the previous word to the current one. Therefore, for every two bits in, the encoder produces three bits out. The Trellis decoder (Viterbi) in a receiver uses the three bits to reconstruct the evolution of the data stream from one two-bit word to the next. The Trellis and Viterbi coding scheme is very effective in managing white noise.

**Multiplexer**

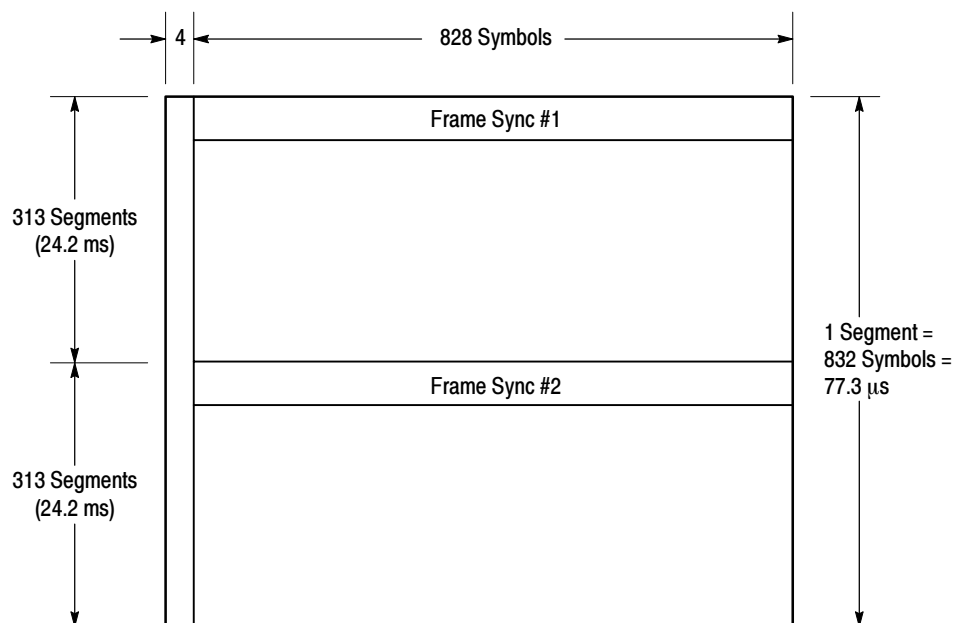
Supplementary sync signals are added to a multiplexer to form the 8VSB baseband signal. Each of the eight levels represents a symbol value. After every 828 symbols, a Segment sync is sent. The Segment sync is two-level binary data that is 10 constellation units peak-to-peak in amplitude and four symbols long. This makes each 8VSB data segment 832 symbols long as shown in Figure 3-16. The Segment sync has two roles: it replaces the sync byte that was removed before the RS encoding, and it increases the signal robustness. It is easily located by the receiver's decoder in the presence of noise.



**Figure 3- 16: Data segment sync**

The other sync signal added to the multiplexer is the Frame synchronizing segment. As shown in Figure 3-17, a transmission data frame is 616 segments (48.4 ms) long. A Frame sync segment is sent every 313 segments (24.2 ms). The Frame sync segment carries the training reference signals for the receiver equalizer. It consists of the following:

- Four byte segment sync.
- Five hundred and eleven reference symbols that the receiver uses for adjusting long equalizer taps.
- Three sets of 63 reference symbols for short equalization.
- Twenty-four symbols for VSB level ID.
- Ninety-two reserved symbols.
- Twelve symbols repeated from the previous segment.



**Figure 3-17: Frame synchronizing segment**

**Pilot Insertion** A small DC offset is added to the baseband signal to produce a pilot at the carrier frequency of the resulting modulated spectrum. The pilot is 0.3 dB of average signal power and is used by the receiver for carrier acquisition. The receiver then uses the Segment sync to lock on the symbol timing.

**VSB Modulation** The 8VSB signal is transmitted as a single sideband suppressed carrier signal. The baseband signal is typically mixed with a 44 MHz signal and passed through a root-raised cosine filter. The output is a 44 MHz IF signal, upper sideband only, with root-raised cosine response.

## Closed-Loop Transmitter Control

This section provides a brief overview of the closed-loop feedback system that can be used to control a transmitter exciter to maintain the signal within required transmitting parameters.

**Correction Processor** A correction processor is either a closed-loop correction system or an open-loop correction system, depending on how advanced the transmitter is. The correction processor is used to shape the exciter signal to precorrect for frequency response and envelope delay errors in the transmitter power amplifier. Precorrection can also reduce non-linear errors.

A closed-loop system samples the outgoing RF to determine what type and how much correction is needed and adjusts the precorrection accordingly. A less advanced transmitter can have an open-loop precorrection system that requires manual adjustments to the controls in a shaping network to produce the corrected output.

# Appendix A: Specifications

This section lists the electrical, physical, and environmental characteristics of the RFA300A Measurement Set 8VSB.

## Specification Tables

The tables list the specifications for the RFA300A Measurement Set 8VSB. All specifications are guaranteed unless labeled typical. Typical specifications are provided for your convenience but are not guaranteed. Specifications marked with the ✓ symbol are checked in the Performance Verification Procedures (refer to the *RFA300A Measurement Set 8VSB Service Manual*).

## Performance Conditions

The Performance requirements are valid within the environmental limits if the instrument was adjusted at  $25\text{ }^{\circ}\text{C} \pm 5\text{ }^{\circ}\text{C}$  and you allowed a minimum warm-up time of 20 minutes.

The measurement set is limited to situations where a single, high-amplitude, 8VSB RF signal is available for direct input to the measurement set.

## RFA300A Measurement Set Specifications

**Table A- 1: Input specifications**

Characteristic	Description
RF Input	
Input Frequency Range	
Demodulation Modes	Channel 7 through Channel 69 (174 MHz to 806 MHz).
Out-of-channel Emission Modes	162 MHz to 818 MHz.
Input impedance	50 $\Omega$ .
↙ Return Loss	
Selected Port	> 25 dB, 174 MHz to 806 MHz.
Nonselected Port (nominally terminated)	$\geq$ 15 dB, 174 MHz to 806 MHz.
RF Inputs Isolation	80 dB, 174 MHz to 806 MHz.
Signal Amplitude	
Without external 10 dB attenuator	1 mW to 1 W (0 dBm to +30 dBm).  <i><b>NOTE.</b> The input power indicator indicates over amplitude power input beginning at 0.2 W (+23 dBm). The variable attenuator of the input circuitry has enough range to handle up to 1 W at the input connector.</i>
With external 10 dB attenuator	10 mW to 2 W (+10 dBm to +33 dBm).
IF Filter	For all measurements requiring demodulation, the 8VSB signal is passed through a DSB-based vestigial sideband IF filter with the characteristics given in the formula shown in Figure A-1.  The formula also defines the idealized frequency response curve of the transmitter.
Adjacent Channels	$\leq$ 50 dB, Analog. $\leq$ 50 dB, Digital.  This specification is the allowable signal amplitude of TV signals other than the one the RFA300A is to measure. It is defined as the ratio of the desired signal's average power divided by the sync tip power of analog TV or average power of DTV signals.
Other Spurious Signals	$\leq$ 50 dB.



$$H(F) = \begin{cases} 0 & -\infty < F \leq \left( F_{Pilot} - \frac{F_{Symbol}\alpha}{4} \right) \\ \sqrt{\frac{1}{2} \left[ 1 + \sin \left( 2\pi \frac{(F - F_{pilot})}{F_{Symbol}\alpha} \right) \right]} & \left( F_{Pilot} - \frac{F_{Symbol}\alpha}{4} \right) < F \leq \left( F_{Pilot} + \frac{F_{Symbol}\alpha}{4} \right) \\ 1 & \left( F_{Pilot} - \frac{F_{Symbol}\alpha}{4} \right) < F \leq \left( F_{Pilot} + \frac{F_{Symbol}}{2} \left( 1 - \frac{\alpha}{2} \right) \right) \\ \sqrt{\frac{1}{2} \left[ 1 - \sin \left( 2\pi \frac{\left( F - F_{Pilot} - \frac{F_{Symbol}}{2} \right)}{F_{Symbol}\alpha} \right) \right]} & \left( F_{Pilot} + \frac{F_{Symbol}}{2} \left( 1 - \frac{\alpha}{2} \right) \right) < F \leq \left( F_{Pilot} + \frac{F_{Symbol}}{2} \left( 1 + \frac{\alpha}{2} \right) \right) \\ 0 & \left( F_{Pilot} + \frac{F_{Symbol}}{2} \left( 1 + \frac{\alpha}{2} \right) \right) < F < \infty \end{cases}$$

Where:

$$F_{Symbol} = \left( \frac{1539}{715} \right) 5 \times 10^6 = 10,762,238 \text{ MHz}$$

Tol:  $\pm 30 \text{ Hz}$

Perform all calculations using the nominal value

$$\alpha = \frac{2(6 \text{ MHz})}{F_{Symbol}} - 1 = 0.1150097$$

Figure A-1: IF filter characteristics

## Measurement Specifications

**Table A-2: Measurement specifications**

Characteristic	Description
S/N (Signal to noise ratio)	<p>S/N is the ratio of ideal signal power to all other signal contributions (such as noise and distortion products). Data is taken only from the I channel (that is the real axis; in phase with the pilot) at each symbol time.</p> $S/N = 20 \log \left[ \frac{\sqrt{\sum_{j=1}^N (I_j^2)}}{\sqrt{\sum_{j=1}^N (\delta I_j^2)}} \right]$ <p>Where:</p> <p>S/N = Signal to Noise Power Ratio in dB.</p> <p>I<sub>j</sub> = Ideal received I-channel signal.</p> <p>δI<sub>j</sub> = Error in the actual received I-channel signal.</p>
S/N Accuracy	Reading is within ± 1 dB of the correct value when S/N ≥ 25 dB with high smoothing.
✓ Residual S/N	<p>≥ 40 dB .</p> <p>The amount of S/N that is created within the RFA300A measurement set.</p>

Table A-2: Measurement specifications (Cont.)

Characteristic	Description
EVM (Error vector magnitude)	<p>EVM is the square root of the mean of the squares (RMS) of the magnitudes of the real axis symbol error vectors, divided by the magnitude of the real (in-phase) part of the outermost ideal constellation state.</p> <p>The symbol error is the difference between the received real axis symbol and its ideal value. EVM is often expressed as a percent.</p> <p>Error Vector Magnitude (EVM) is defined by the following formula:</p> $EVM_{RMS} = \sqrt{\frac{\frac{1}{N} \sum_{j=1}^N \delta I_j^2}{S_{max}^2}} \times 100\%$ <p>Where:</p> <p><math>EVM_{RMS}</math> = Error Vector Magnitude (%).</p> <p><math>\delta I_j</math> = The error in the real axis received signal value.</p> <p><math>S_{max}</math> = Magnitude of the real (in-phase) part of the vector to the outermost state of the constellation.</p> <p>EVM can also be expressed in terms of dB, where <math>EVM_{dB} = 20 \cdot \log(100/EVM\%)</math>. Note that the ratio is intentionally inverted to make the value in dB positive.</p>
EVM Accuracy	<p>± 12% of the correct reading.</p> <p>When S/N ≥ 25 dB with high smoothing.</p>
✓ Residual EVM	<p>≤ 1%.</p> <p>Residual EVM is created within the RFA300A measurement set.</p>

**Table A-2: Measurement specifications (Cont.)**

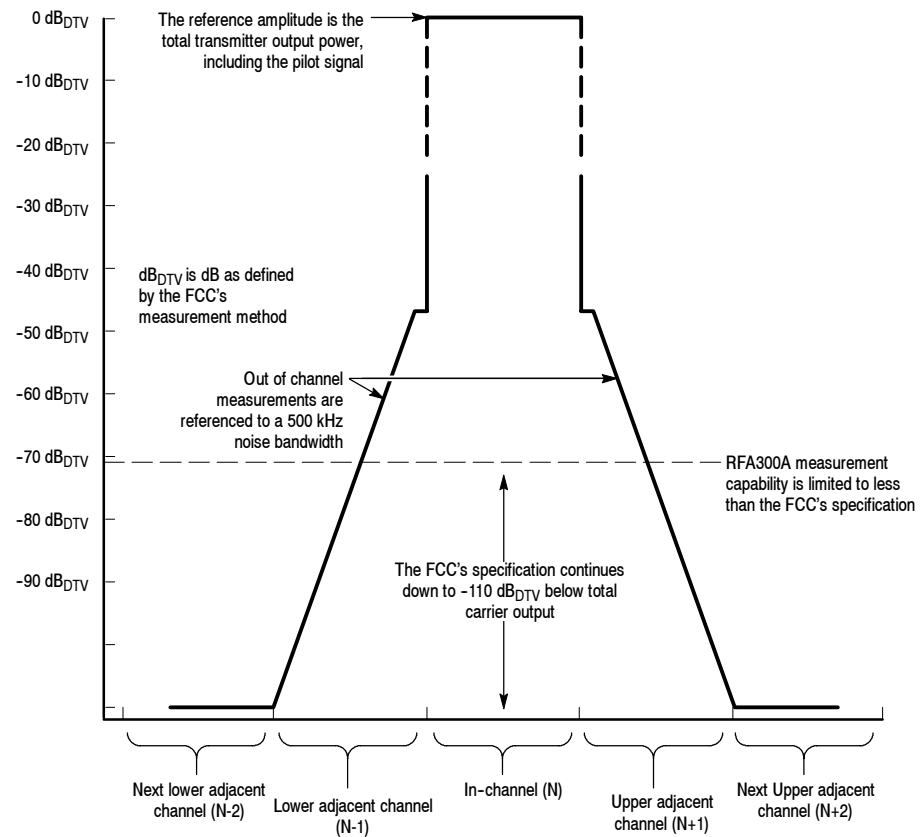
Characteristic	Description
Complex MER (Modulation Error Ratio)	<p>Complex Modulation Error Ratio (Complex MER) is a complex form of the S/N measurement that is made by including Q (quadrature) channel information in the ideal and error signal power computations, similar to EVM. MER is defined by the following formula:</p> $MER = 20 \log \left[ \frac{\sqrt{\sum_{j=1}^N (I_j^2 + Q_j^2)}}{\sqrt{\sum_{j=1}^N (\delta I_j^2 + \delta Q_j^2)}} \right]$ <p>Where:</p> <p>MER = Modulation error ratio.</p> <p><math>I_j</math> and <math>Q_j</math> = Ideal I-channel and Q-channel symbols.</p> <p><math>\delta I_j</math> and <math>\delta Q_j</math> = Errors between received and ideal I-channel and Q-channel symbols.</p>
MER Accuracy	<p><math>\pm 1</math> dB of the correct reading.</p> <p>When S/N <math>\geq 25</math> dB with high smoothing.</p>
✓ Residual MER	<p><math>\geq 40</math> dB.</p> <p>Residual MER is created within the RFA300A measurement set.</p>
Pilot Amplitude Deviation	<p><math>\pm (0.1 \text{ dB} + 0.2 \times \text{deviation reading}) \text{ dB}</math>.</p> <p>When S/N <math>\geq 25</math> dB with high smoothing.</p>

Table A-2: Measurement specifications (Cont.)

Characteristic	Description
Out-of-Channel Emissions	<p>Out of channel emissions are spectral power versus frequency measurements, similar to those made by a spectrum analyzer.</p> <p>FCC Out of Channel Emissions Standard as referenced to MM Docket No. 87-268. In the first 500 kHz from the authorized channel edge, transmitter emissions must be attenuated no less that 47 dB below the average transmitted power. More than 6 MHz from the channel edge, emissions must be attenuated no less than 110 dB below the average transmitted power. At any frequency between 0.5 MHz and 6 MHz from the channel edge, emissions must be attenuated no less than the value determined by the following formula:</p> $\text{Attenuation in dB} = -11.5(\Delta f + 3.6)$ <p>where <math>\Delta f</math> = frequency difference in MHz from the edge of the channel.</p> <p>All attenuation limits are based on a measurement bandwidth of 500 kHz. The 8 VSB Transmitter Emissions Mask for the measurements is shown in Figure A-2. This mask lowers the power radiated in the adjacent channel to a level of -44 dB below the average power transmitted. Other measurement bandwidths may be used as long as the appropriate correction factors are applied. In the event interference is caused to any service, greater attenuation may be required.</p>
✓ Measurement Limit	$\geq -71 \text{ dB}_{\text{DTV}}$ $\text{dB}_{\text{DTV}}$ is dB as defined by the FCC's measurement method.
✓ Out-of-Channel Accuracy	$\pm 2 \text{ dB}$ over a range of $\pm 12 \text{ MHz}$ with respect to the edges of the channel in use.
Upper/Lower Channel Power Accuracy	$\pm 3 \text{ dB}$ . Shows the integrated power present in the upper and lower adjacent channels.
Transmitter Frequency Response Error	Plots the deviation of the transmitter's spectral amplitude as a function of frequency with respect to the ideal 8VSB root-cosine transmitter curve.
Frequency range	Measurements are made from 0 to +5.68 MHz with respect to the pilot frequency of the signal under test.
Display accuracy	$\pm (0.25 + 0.05 \times \text{p-p measured amplitude deviation}) \text{ dB}$ .
✓ Residual Flatness Error	0.25 dB peak-to-peak error over the frequency range.
Transmitter Group Delay	Plots deviation of the transmitter's spectral group delay response from the ideal. The ideal group delay response is zero variation over the channel bandwidth.
Frequency Range	From 0 kHz to +5.68 MHz with respect to the pilot frequency of the signal under test.
Display Accuracy	$\pm (4 + 0.2 \times \text{p-p measured group delay deviation}) \text{ ns}$ .
✓ Residual Group Delay Error	8 ns peak-to-peak over the frequency range.
Amplitude Error	Plots the transmitter's instantaneous amplitude error as a function of amplitude. This error is typically caused by an amplifier's gain changing because of signal amplitude.
Accuracy	$\pm (0.1 + 0.2 \times \text{p-p dB p-p measured amplitude error}) \text{ dB}$ .
Phase Error	Plots the signal's instantaneous phase error as a function of amplitude. This error is typically caused by variation of an amplifier's phase because of signal amplitude.
Residual Phase Accuracy	$\pm (5 + 0.2 \times \text{p-p degrees measured error}) \text{ degree}$ .

**Table A-2: Measurement specifications (Cont.)**

Characteristic	Description
Phase Noise	
Phase Noise Marker Accuracy	± 5 dB.
Residual Phase Noise	≤ -105 dBc/Hz at 20 kHz carrier offset. This is the single sideband noise exhibited by the RFA300A local oscillator.
Residual Phase Jitter	≤ 5 milliradians RMS, integrated over the range from 2 kHz to 300 kHz.
Peak to Average Ratio	
Marker Accuracy	± 1 dB.



**Figure A-2: 8VSB transmitter emissions mask**

## System Components

**Table A-3: System components**

Characteristic	Description
Mainframe	Tektronix manufactured, common-platform mainframe
Form Factor	Rack-mountable in standard 19-inch rack
Processor	Two 400 MHz Pentium II processors
System Memory	256 MB
Real Time Clock	Real-time clock/calendar with a resolution of 1 second or less
Retention Time: Real-time clock, CMOS setup, and PnP NVRAM	Projected battery life is 10 years
BIOS	DTI BIOS, field upgradable
Bus	32-bit PCI
Expansion Slots	8 PCI slots
Graphics	640 × 480 VGA resolution with up to 16 million colors.
Non-volatile Storage	
Floppy Disk drive	3.5 inch PC compatible floppy disk drive; 1.44 Mbyte high-density double sided (2HD)
CD-ROM drive	PC compatible half height IDE CDROM drive, 24X
Hard Disk Drives	20 GB EIDE HDD
Mainframe Interfaces	<p>One loop-through ethernet port</p> <p>One bi-directional RS-232/RS-422/RS-485 port</p> <p>One alarm relay out</p> <p>One parallel port (printer)</p> <p>Two hot-pluggable keyboard ports (one on the rear panel, one on the left front side panel)</p> <p>Two hot-pluggable mouse ports (one on the rear panel, one on the left front side panel)</p>





**Table A- 5: Rear panel interface characteristics**

Characteristic	Description																										
Parallel Interface Port	<p>Port supports standard Centronics mode, Enhanced Parallel Port (EPP), or Microsoft high-speed mode (ECP) and uses a 25-pin D connector.</p> <p>Compliant with IEEE P1284-DB25 for bi-directional Parallel Peripheral Interface for Personal Computers 1284-1994, IEEE.</p> <p>Pin assignments for compatible mode:</p> <table data-bbox="695 596 1201 1094"> <tbody> <tr> <td>1. SRTB*</td> <td>14. AUTOFEED*</td> </tr> <tr> <td>2. DATA0</td> <td>15. ERR*</td> </tr> <tr> <td>3. DATA1</td> <td>16. INIT*</td> </tr> <tr> <td>4. DATA2</td> <td>17. SELIN*</td> </tr> <tr> <td>5. DATA3</td> <td>18. GND</td> </tr> <tr> <td>6. DATA4</td> <td>19. GND</td> </tr> <tr> <td>7. DATA5</td> <td>20. GND</td> </tr> <tr> <td>8. DATA6</td> <td>21. GND</td> </tr> <tr> <td>9. DATA7</td> <td>22. GND</td> </tr> <tr> <td>10. ACK*</td> <td>23. GND</td> </tr> <tr> <td>11. BUSY</td> <td>24. GND</td> </tr> <tr> <td>12. PMT</td> <td>25. GND</td> </tr> <tr> <td>13. SEL</td> <td></td> </tr> </tbody> </table> <p>* See IEEE P1284-A in IEEE Standard 1284-1994 for pin connection definitions for other modes.</p>	1. SRTB*	14. AUTOFEED*	2. DATA0	15. ERR*	3. DATA1	16. INIT*	4. DATA2	17. SELIN*	5. DATA3	18. GND	6. DATA4	19. GND	7. DATA5	20. GND	8. DATA6	21. GND	9. DATA7	22. GND	10. ACK*	23. GND	11. BUSY	24. GND	12. PMT	25. GND	13. SEL	
1. SRTB*	14. AUTOFEED*																										
2. DATA0	15. ERR*																										
3. DATA1	16. INIT*																										
4. DATA2	17. SELIN*																										
5. DATA3	18. GND																										
6. DATA4	19. GND																										
7. DATA5	20. GND																										
8. DATA6	21. GND																										
9. DATA7	22. GND																										
10. ACK*	23. GND																										
11. BUSY	24. GND																										
12. PMT	25. GND																										
13. SEL																											
Serial Interface Port (on back panel)	<p>9-pin male D-sub connector RS232</p> <p>Pin Assignments:</p> <table data-bbox="695 1276 1107 1463"> <tbody> <tr> <td>1. DCD</td> <td>6. DSR</td> </tr> <tr> <td>2. RXD</td> <td>7. RTS</td> </tr> <tr> <td>3. TXD</td> <td>8. CTS</td> </tr> <tr> <td>4. DTR</td> <td>9. RI</td> </tr> <tr> <td>5. GND</td> <td></td> </tr> </tbody> </table>	1. DCD	6. DSR	2. RXD	7. RTS	3. TXD	8. CTS	4. DTR	9. RI	5. GND																	
1. DCD	6. DSR																										
2. RXD	7. RTS																										
3. TXD	8. CTS																										
4. DTR	9. RI																										
5. GND																											

**Table A-5: Rear panel interface characteristics (Cont.)**

Characteristic	Description																
SVGA Output Port	<p>15-pin female high density-D-sub SVGA connector. Compliant with EIA RS 343A. Selectable 640 X 480 (VGA), 800 X 600, and 1024 X 768 (SVGA). When internal display is active, VGA mode must be selected for this SVGA output port.</p> <p>Pin assignments:</p> <table data-bbox="662 554 1110 856"> <tr> <td>1. Red</td> <td>9. (key)</td> </tr> <tr> <td>2. Green</td> <td>10. GND</td> </tr> <tr> <td>3. Blue</td> <td>11. NC</td> </tr> <tr> <td>4. NC</td> <td>12. NC</td> </tr> <tr> <td>5. GND</td> <td>13. HSYNC</td> </tr> <tr> <td>6. AGND</td> <td>14. VSYNC</td> </tr> <tr> <td>7. AGND</td> <td>15. NC</td> </tr> <tr> <td>8. AGND</td> <td></td> </tr> </table>	1. Red	9. (key)	2. Green	10. GND	3. Blue	11. NC	4. NC	12. NC	5. GND	13. HSYNC	6. AGND	14. VSYNC	7. AGND	15. NC	8. AGND	
1. Red	9. (key)																
2. Green	10. GND																
3. Blue	11. NC																
4. NC	12. NC																
5. GND	13. HSYNC																
6. AGND	14. VSYNC																
7. AGND	15. NC																
8. AGND																	
Ethernet Port	<p>10 Base-T/100 Base-T on PCI bus, RJ45 Connector, Plug &amp; Plan compatible, Bus master mode.</p> <p>RJ45 Pin assignments:</p> <table data-bbox="662 982 1062 1129"> <tr> <td>1. TX+</td> <td>5. NC</td> </tr> <tr> <td>2. TX-</td> <td>6. RX-</td> </tr> <tr> <td>3. RX+</td> <td>7. NC</td> </tr> <tr> <td>4. NC</td> <td>8. NC</td> </tr> </table>	1. TX+	5. NC	2. TX-	6. RX-	3. RX+	7. NC	4. NC	8. NC								
1. TX+	5. NC																
2. TX-	6. RX-																
3. RX+	7. NC																
4. NC	8. NC																
Alarm Contacts	<p>DB-9 female connector. C-form relay contacts change state upon an alarm condition</p> <p>Contact Ratings 28 V, 2A maximum.</p> <p>Pin assignments:</p> <table data-bbox="662 1255 867 1350"> <tr> <td>1. Normally closed</td> </tr> <tr> <td>3. Common</td> </tr> <tr> <td>5. Normally open</td> </tr> </table>	1. Normally closed	3. Common	5. Normally open													
1. Normally closed																	
3. Common																	
5. Normally open																	

## Power Characteristics

**Table A- 6: AC power source characteristics**

<b>Characteristic</b>	<b>Description</b>
Source Voltage	Range for the line voltage needed to power the measurement set to meet performance requirements. 90 VAC to 250 VAC RMS, 47 Hz to 63 Hz, continuous range CAT II
Fuse Rating	10 A Fast / 250 V
Maximum Power Consumption	540 Watts max, 170 Watts typical
Steady State Input Current	6 Amps max, 1.9 Amps RMS typical
Inrush Surge Current	65 Amps maximum
Power Factor Correction	Yes

## Environmental Characteristics

**Table A-7: Environmental characteristics**

Characteristic	Description
Cooling airflow	Intake is from the front and sides of the instrument. Exhaust is to the bottom and rear of the instrument.
Required Clearance	2 in. (50 mm) air space adjacent to the bottom of the instrument is required.
Use Rating	Rated for indoor use only.
Atmospherics	
Temperature:	
Operating (meeting accuracy specifications)	+5 °C to 45 °C (32 °F to 113 °F), 30 °C/hr max gradient, non-condensing (derated 1 °C or 1.8 °F per 1,000 ft. or 305 m above 5,000 ft. or 1524 m altitude)
Operating (without damage)	+5 °C to 50 °C (32 °F to 122 °F), 30 °C (54 °F)/hr max gradient, non-condensing (derated 1 °C per 1,000 ft. or 305 m above 5,000 ft or 1524 m altitude)  With a floppy diskette media in the floppy drive the operating specification lower limit is 10 °C (50 °F).
Non-operating	-20 °C to 60 °C (-4 °F to 140 °F), 30 °C (54 °F)/hr max gradient, non-condensing.
Humidity	
Operating	20% to 80% relative humidity, non-condensing. Max wet bulb temperature: 31 °C or 87.8 °F (at 50 °C or 122 °F, maximum relative humidity is ~50%).
Non-operating	8% to 80% relative humidity, non-condensing. Max wet bulb temperature: 40 °C or 104 °F (at 50 °C or 122 °F, maximum relative humidity is ~50%).
Altitude	
Operating	Up to 10,000 ft. (3,040m), (derated 1 °C or 1.8 °F per 1,000 ft. [305 m] above 5,000 ft. [1524 m] altitude)
Non-Operating	40,000 ft (12,190 m)

**Table A-8: Dynamics**

<b>Characteristic</b>	<b>Description</b>
Random Vibration:	
Operating	0.27 g <sub>RMS</sub> total from 5 to 500 Hz, 10 minutes each axis, 3-axes, 30 minutes total.
Non-Operating	2.28 g <sub>RMS</sub> total from 5 to 500 Hz, 10 minutes each axis, 3-axes, 30 minutes total.
Functional Shock:	
Non-Operating	Half-sine, 20 g's, 11ms duration. 3 drops each side, 18 shocks total (no media in floppy disk drive).

**Table A-9: Transportation**

<b>Characteristic</b>	<b>Description</b>
Transportation Package Material	Transportation Package material meets recycling criteria as described in Environmental Guidelines for Package Design (Tektronix 063-1290-00) and Environmentally Responsible Packaging Handbook (Tektronix 063-1302-00).

## Certifications and Compliances

**Table A- 10: Certifications and compliances**

Category	Standards or description																		
EC Declaration of Conformity - EMC	<p>Meets intent of Directive 89/336/EEC for Electromagnetic Compatibility. Compliance was demonstrated using:</p> <p>EN 61326: 1997 Product Family Standard for Electrical Equipment for Measurement, Control, and Laboratory Use-EMC Requirements.<sup>1</sup></p> <p>Emissions:</p> <table border="0"> <tr> <td>EN 61326</td> <td>Class A Radiated and Conducted Emissions</td> </tr> <tr> <td>IEC 61000-3-2</td> <td>Conducted Power Line Harmonic Currents</td> </tr> </table> <p>Immunity:</p> <table border="0"> <tr> <td>IEC 61000-4-2</td> <td>Electrostatic Discharge <sup>2</sup></td> </tr> <tr> <td>IEC 61000-4-3</td> <td>Radiated RF Electromagnetic Field <sup>2,4</sup></td> </tr> <tr> <td>IEC 61000-4-4</td> <td>Electrical Fast Transient/Burst <sup>3</sup></td> </tr> <tr> <td>IEC 61000-4-5</td> <td>Surge <sup>2</sup></td> </tr> <tr> <td>IEC 61000-4-6</td> <td>Conducted RF <sup>2,4</sup></td> </tr> <tr> <td>IEC 61000-4-8</td> <td>Power Frequency Magnetic Field <sup>2</sup></td> </tr> <tr> <td>IEC 61000-4-11</td> <td>Power line Fluctuation <sup>3</sup></td> </tr> </table>	EN 61326	Class A Radiated and Conducted Emissions	IEC 61000-3-2	Conducted Power Line Harmonic Currents	IEC 61000-4-2	Electrostatic Discharge <sup>2</sup>	IEC 61000-4-3	Radiated RF Electromagnetic Field <sup>2,4</sup>	IEC 61000-4-4	Electrical Fast Transient/Burst <sup>3</sup>	IEC 61000-4-5	Surge <sup>2</sup>	IEC 61000-4-6	Conducted RF <sup>2,4</sup>	IEC 61000-4-8	Power Frequency Magnetic Field <sup>2</sup>	IEC 61000-4-11	Power line Fluctuation <sup>3</sup>
EN 61326	Class A Radiated and Conducted Emissions																		
IEC 61000-3-2	Conducted Power Line Harmonic Currents																		
IEC 61000-4-2	Electrostatic Discharge <sup>2</sup>																		
IEC 61000-4-3	Radiated RF Electromagnetic Field <sup>2,4</sup>																		
IEC 61000-4-4	Electrical Fast Transient/Burst <sup>3</sup>																		
IEC 61000-4-5	Surge <sup>2</sup>																		
IEC 61000-4-6	Conducted RF <sup>2,4</sup>																		
IEC 61000-4-8	Power Frequency Magnetic Field <sup>2</sup>																		
IEC 61000-4-11	Power line Fluctuation <sup>3</sup>																		
FCC Compliance	Emissions comply with FCC Code of Federal Regulations 47, Part 15, Subpart B, Class A Limits. <sup>1</sup>																		
EC Declaration of Conformity - Low Voltage	<p>Compliance was demonstrated to the following specification as listed in the Official Journal of the European Union:</p> <p>Low Voltage Directive 73/23/EEC, amended by 93/69/EEC</p> <table border="0"> <tr> <td>EN 61010-1:1993</td> <td>Safety requirements for electrical equipment for measurement control and laboratory use.</td> </tr> </table>	EN 61010-1:1993	Safety requirements for electrical equipment for measurement control and laboratory use.																
EN 61010-1:1993	Safety requirements for electrical equipment for measurement control and laboratory use.																		
U.S. Nationally Recognized Testing Laboratory Listing	<table border="0"> <tr> <td>ANSI/ISA S82.01:1994</td> <td>Safety standard for electrical and electronic test, measuring, controlling, and related equipment.</td> </tr> </table>	ANSI/ISA S82.01:1994	Safety standard for electrical and electronic test, measuring, controlling, and related equipment.																
ANSI/ISA S82.01:1994	Safety standard for electrical and electronic test, measuring, controlling, and related equipment.																		
Canadian Certification	<table border="0"> <tr> <td>CAN/CSA C22.2 No. 1010.1</td> <td>Safety requirements for electrical equipment for measurement, control, and laboratory use.</td> </tr> </table>	CAN/CSA C22.2 No. 1010.1	Safety requirements for electrical equipment for measurement, control, and laboratory use.																
CAN/CSA C22.2 No. 1010.1	Safety requirements for electrical equipment for measurement, control, and laboratory use.																		
Additional Compliance	<table border="0"> <tr> <td>UL3111-1</td> <td>Standard for electrical measuring and test equipment.</td> </tr> <tr> <td>IEC61010-1</td> <td>Safety requirements for electrical equipment for measurement, control, and laboratory use.</td> </tr> </table>	UL3111-1	Standard for electrical measuring and test equipment.	IEC61010-1	Safety requirements for electrical equipment for measurement, control, and laboratory use.														
UL3111-1	Standard for electrical measuring and test equipment.																		
IEC61010-1	Safety requirements for electrical equipment for measurement, control, and laboratory use.																		

**1 Compliance demonstrated using high-quality shielded interface cables.**

**2 EN 61326 Immunity Test requirement for Industrial Location intended use.**

**3 EN 61326 Minimum Immunity Test requirement.**

**4 Performance Criteria: Signal/Noise Ratio greater than or equal to 38 dB.**

**Table A- 10: Certifications and compliances (Cont.)**

<b>Category</b>	<b>Standards or description</b>
Installation (Overvoltage) Category	<p>Terminals on this product may have different installation (overvoltage) category designations. The installation categories are:</p> <p>CAT III Distribution-level mains (usually permanently connected). Equipment at this level is typically in a fixed industrial location.</p> <p>CAT II Local-level mains (wall sockets). Equipment at this level includes appliances, portable tools, and similar products. Equipment is usually cord-connected.</p> <p>CAT I Secondary (signal level) or battery operated circuits of electronic equipment.</p>
Pollution Degree	<p>A measure of the contaminates that could occur in the environment around and within a product. Typically the internal environment inside a product is considered to be the same as the external. Products should be used only in the environment for which they are rated.</p> <p>Pollution Degree 1 No pollution or only dry, nonconductive pollution occurs. Products in this category are generally encapsulated, hermetically sealed, or located in clean rooms.</p> <p>Pollution Degree 2 Normally only dry, nonconductive pollution occurs. Occasionally a temporary conductivity caused by condensation must be expected. This location is a typical office/home environment. Temporary condensation occurs only when the product is out of service.</p> <p>Pollution Degree 3 Conductive pollution, or dry, nonconductive pollution that becomes conductive due to condensation. These are sheltered locations where neither temperature nor humidity is controlled. The area is protected from direct sunshine, rain, or direct wind.</p>
Laser Classification	This product contains a CD ROM drive which utilizes a Class 1 laser and complies with EN60825-1:94 and with the U.S. FDA regulations. The drive is marked with the laser's classification and date of manufacture, as well as the following information: Complies with the DHHS rules 21 CFR Chapter 1, Subchapter J applicable at the date of manufacture.
<b>Safety standards</b>	
Safety Certification Compliance	
Temperature, operating	+5 to +50 °C
Altitude (maximum operating)	3000 meters
Equipment Type	Test and measuring
Safety Class	Class 1 (as defined in IEC 1010-1, Annex H) - grounded product
Installation (Overvoltage) Category	Overvoltage Category II (as defined in IEC 1010-1, Annex J)
Pollution Degree	Pollution Degree 2 (as defined in IEC 1010-1). Note: Rated for indoor use only.
Supply Voltage Range	100 - 240 VAC 50/60 Hz, single phase
Current Rating	6.0 Amps max
Fuse Rating	Mains fuse is 10A, 250V, Fast; Not operator replaceable. Refer servicing to qualified service personnel.
Relative Humidity (maximum operating)	80 % for temperatures up to 31 °C, decreasing linearly to 50 % at 40 °C

## Mechanical (Physical) Characteristics

**Table A- 11: Mechanical characteristics**

<b>Characteristic</b>	<b>Description</b>
Classification	Transportable platform intended for design and development bench/lab-based applications.
Overall Dimensions	
Height without feet	8.9 inches (22.5 cm)
Width	16.75 inches (42.5 cm)
Depth	21.5 inches (55.0 cm)
Weight	
RFA300A	33 lb (15.0 kg) without accessories
Shipping Weight	60 lb (27.2 kg)
Construction Materials	Chassis parts are constructed of aluminum alloy and aluminized steel; front panel and trim pieces are constructed of plastic; circuit boards are constructed of glass and/or ceramic-glass laminate.



# Appendix B: User Service

This appendix describes general care and service procedures for the RFA300A Measurement Set 8VSB.

Instrument and module service troubleshooting procedures are located in the service manual (refer the *Preface* for a list of manuals).

## General Care

Protect the instrument from adverse weather conditions. The instrument is not waterproof.

Do not store or leave the instrument where the LCD display will be exposed to direct sunlight for long periods.



---

**CAUTION.** *To avoid damage to the instrument, do not expose it to sprays, liquids, or solvents.*

---

## Preventive Maintenance

Check the electrical performance and the instrument accuracy certified (calibrated) once a year.

Preventive maintenance mainly consists of periodic cleaning. Periodic cleaning reduces instrument breakdown and increases reliability. You should clean the instrument as needed, based on the operating environment. Dirty conditions may require more frequent cleaning than computer room conditions.

### Cleaning the Exterior

Clean the exterior surfaces of the instrument with a dry, lint-free cloth or a soft-bristle brush. If dirt remains, use a cloth or swab dampened with a 75% isopropyl alcohol solution. A swab is useful for cleaning in narrow spaces around the controls and connectors. Do not use abrasive compounds on any part of the instrument.



---

**CAUTION.** *Avoid getting moisture inside the instrument during external cleaning; and use only enough solution to dampen the cloth or swab.*

*Do not wash the front-panel On/Standby switch. Cover the switch while cleaning the instrument.*

*Use a 75% isopropyl alcohol solution as a cleanser and rinse with deionized water.*

*Do not use chemical cleaning agents; they may damage the instrument. Avoid chemicals that contain benzene, toluene, xylene, acetone, or similar solvents.*

---

### **Cleaning the Display**

Clean the face of the display using a soft cloth dampened with deionized water.

### **Cleaning the Compact Disc Drive**

The compact disc (CD) drive requires routine maintenance to operate at maximum efficiency. The CDs can be damaged if dirt and dust accumulate on the surface. Store the CDs in their protective containers where they will not be exposed to dust or dirt.



---

**CAUTION.** *Electrostatic discharge (ESD) can damage components in the CD ROM drive. Do not touch lens or exposed metallic parts on the platter.*

---

Clean the face of the CD drive monthly with a cloth dampened with deionized water.



---

**CAUTION.** *Do not allow moisture to enter the disk drive. When power is applied, the internal components may be damaged.*

---

## Cleaning the Keyboard and Mouse

Clean the exterior surfaces of the keyboard and mouse with a dry, lint-free cloth or a soft-bristle brush. A swab is useful for cleaning in narrow spaces around the controls and connectors. Do not use abrasive compounds on any part of the instrument.



---

**CAUTION.** *Avoid getting moisture inside the keyboard and mouse during external cleaning; use only enough solution to dampen the cloth or swab.*

*Clean with a 75% isopropyl alcohol solution and rinse with deionized water.*

*Do not use chemical cleaning agents; they may damage the instrument. Avoid chemicals that contain benzene, toluene, xylene, acetone, or similar solvents.*

---

## In Case of Problems

This section addresses problems that you may encounter while using the measurement set. This section does not identify specific problems relating to performance verification or adjustments. For information on running performance verification procedures or adjustment procedures, refer to the *RFA300A Measurement Set 8VSB Service Manual*, available as an optional accessory.

### Diagnostics

Use diagnostics to isolate problems to software or hardware within the instrument. For additional help on diagnostics, contact your local Tektronix representative. The following diagnostic tools are available with your measurement set:

- **Power-on diagnostics.** These diagnostics run when you first power on the instrument or when you first start the measurement set application. If any diagnostic failures are detected during power on, the Power-On Diagnostics dialog box appears.
- **Extended diagnostics.** These diagnostics test the instrument more thoroughly than the power-on diagnostics. You can use extended diagnostics to isolate problems down to an individual module. The extended diagnostics are part of the measurement set application. To run extended diagnostics, go to the Tools menu, select Diagnostics, and click the Extended Diagnostics tab.

### Software Problems

The RFA300A Measurement Set 8VSB is shipped with software already installed. For any suspected software problems, try to isolate the problem to the measurement set application software or to other installed software.

Software problems can be caused by corrupted or missing software files. Often the easiest way to solve software problems is to reinstall the software. Refer to *Appendix C: Software Installation* for instructions on reinstalling software.

Table B-1 lists some of the symptoms of software problems and possible solutions.

If you suspect problems with the software, contact your local Tektronix representative or refer to *Contacting Tektronix* in the *Preface*.

**Hardware Problems**

Hardware problems can have several causes. The first step to identifying a problem is to review the installation instructions in this manual to verify that you have properly installed the instrument. The second step is to determine if the problem is in the mainframe or the measurement set’s modules.

If you are certain that you have installed the instrument correctly, run the extended diagnostics (located under the tools menu) to identify any problems with the individual modules.

Table B-1 lists some of the symptoms of hardware problems and possible solutions.

**Table B-1: Troubleshooting**

Symptom	Possible causes and recommended actions
Instrument does not power on	<p>Verify that the power cord is connected to the instrument and to the power source.</p> <p>Check that the instrument receives power when you press the On/Standby switch; check that fans start and that front-panel indicators light.</p> <p>Check that power is available at the power source.</p> <p>Instrument failure; contact your local Tektronix service center.</p>
Instrument powers on but does not complete the power-on sequence	<p>Check for and remove any disk in the floppy disk drive; make sure instrument boots from the hard disk drive.</p> <p>Possible software failure or corrupted hard disk. Refer to <i>Software Problems</i> at the beginning of this chapter.</p>
Power-on diagnostics fail	<p>Isolate problem to faulty platform or to faulty module. Contact your local Tektronix service center.</p>
Instrument does not recognize accessories such as monitor, printer, or keyboard	<p>Check that accessories are properly connected or installed. Contact your local Tektronix service center.</p>
Windows NT comes up but the measurement set application does not	<p>Instrument not set up to start measurement set application at power on; start application from the desktop by double clicking on the RFA300A icon. Make sure the Start/Programs/Startup folder contains a shortcut to the measurement set application.</p> <p>Faulty or corrupt software, refer to <i>Software Problems</i> at the beginning of this chapter.</p>
Windows NT comes up in Safe mode	<p>Exit the Safe mode and restart the instrument.</p>
Instrument will not power off with On/Standby switch	<p>Windows NT operating system problem. Try powering off the instrument using the Windows NT shutdown procedure. If the instrument still does not power off, push and hold the On/Standby switch for five seconds to power off the instrument.</p>

## Repackaging for Shipment

Your instrument was originally shipped by Tektronix in a carton with packaging components designed to protect the instrument from damage during shipment. If you need to ship the instrument to another location, it is strongly recommended that you use the original shipping carton and packaging components to provide adequate protection during shipment.



---

**CAUTION.** *To prevent the loss of your instrument's warranties, Tektronix strongly recommends that you use your original shipping carton (one that is in good condition) when you ship the instrument to another location or when you return the instrument to a Tektronix service center for repair.*

*Tektronix cannot honor the instrument's warranties if the instrument arrives at the service center damaged and it was not shipped in its original carton or in a replacement carton (and its supporting packaging material) purchased from Tektronix. If you lose your original packaging material, contact your Tektronix representative to obtain replacement packaging.*

---

### Packaging Inspection

When preparing to ship your instrument to another location, it is important to inspect your existing packaging materials for condition, missing components and vintage.

- If the condition of your existing packaging materials is poor, or if you are missing some of the components, it is strongly recommended that you order a new packaging kit. The new packaging kit will accommodate both the portable and the rackmount versions of the instrument cabinet.

If your existing packaging materials are in good condition, compare them against Figures B-1 and B-2 to determine which packaging procedure to use. Use the procedure associated with your existing packaging materials.

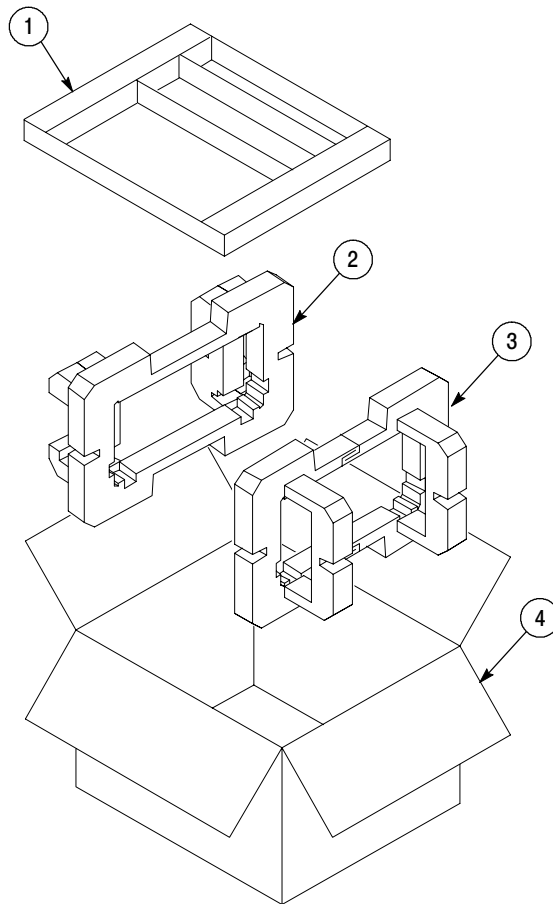
- The configuration (vintage) of the packaging materials is important to note. Replacement components for the old-design packaging materials are no longer available. Also, the components of the new and old designs are not interchangeable. If your packaging materials are of the old design, and require any replacement components, you must order a new packaging kit.

If your instrument was originally shipped in the older design packaging and you have converted the cabinet from portable to rackmount configuration, use the new design packaging which contained the rackmount conversion kit, or order a new design shipping kit.

### Replacement Packaging Materials

New packaging materials are available from Tektronix. To obtain these items, contact your nearest Tektronix representative.

The replacement packaging kit, Tektronix part number 065-0651-XX, includes all of the packaging material shown in Figure B-1. Each packaging component in the illustration has an index number, which corresponds to reference numbers in the packaging procedure.



Note: The keyboard, mouse, manual, and their boxes do not need to be returned with the instrument for servicing. A protective bag for the instrument is included in the packaging kit, but is not shown.

**Figure B-1: Repackaging the instrument (new packaging)**

**Repackaging Procedure  
(New Design)**

When the instrument is shipped, it is important to package it well to protect the instrument. Figure B-1 shows how to repackage the instrument for shipment using the new packaging materials. It is not necessary to return the accessories received with the instrument when returning the instrument for repair.

---

**NOTE.** *The packaging materials illustrated in Figure B-1 will accommodate both the portable and the rackmount versions of the instrument cabinet.*

---

1. If the instrument is to be shipped to a Tektronix field office for repair, attach a tag to the instrument showing the following:
  - Owner's name and address
  - Instrument serial number
  - Description of the problem(s) encountered and/or service required.
2. Place the protective front cover on the front of the instrument.
3. Place the instrument in the protective bag. The bag prevents dust moisture, or other debris from entering the cabinet.
4. Fold the top of the bag neatly over the top of the instrument to make it as flat as possible and seal with packing tape.
5. Place the front cushion (3) over the front of the instrument.
6. Place the rear cushion (2) over the rear of the instrument.
7. Carefully lift the instrument with front and rear cushions attached and lower into the shipping box (4) as indicated by Figure B-1.
8. Position the tray (1) into the top of the box, pressing the tray down until it rests on the tops of the front and rear cushions.

---

**NOTE.** *To ensure packaging integrity and product safety, the tray (1) must be installed regardless if any accessories are being included in the package.*

---

9. If you are shipping the accessories, arrange the accessories in the tray.
10. Close and tape the shipping box.
11. Attach the appropriate shipping documents needed to ship the instrument to its destination.

### Repackaging Procedure (Old Design)

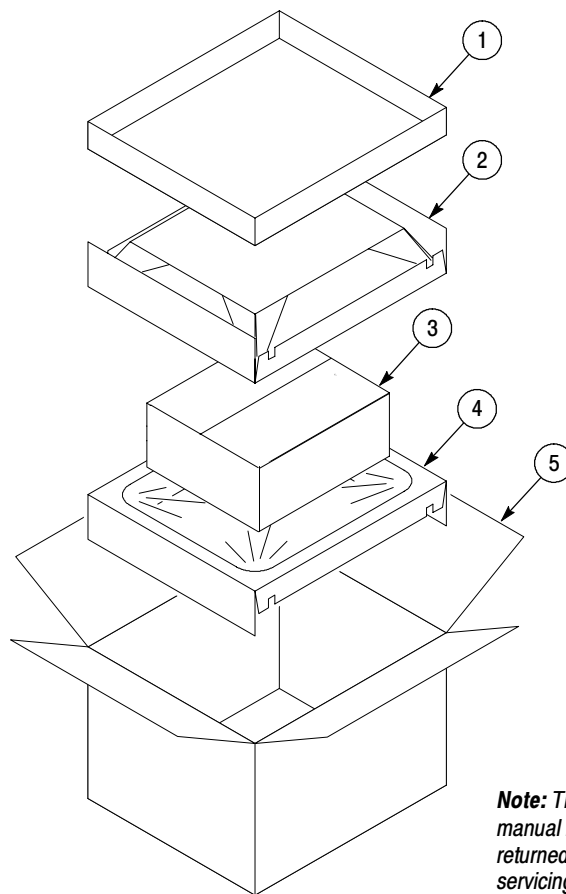
If your instrument was shipped in the older packaging materials as shown in Figure B-2, inspect your existing packaging materials to make sure they are complete and in good condition as described in *Packaging Inspection* on page B-5. If your existing earlier packaging materials are in good condition, follow the procedure below to repackage your instrument for shipment.

When the instrument is shipped, it is important to package it well to protect the instrument. Figure B-2 shows how to repackage the instrument for shipment using the old packaging materials. It is not necessary to return the accessories received with the instrument when returning the instrument for repair.

---

**NOTE.** *The packaging materials illustrated in Figure B-2 will accommodate only the portable version of the instrument cabinet.*

---



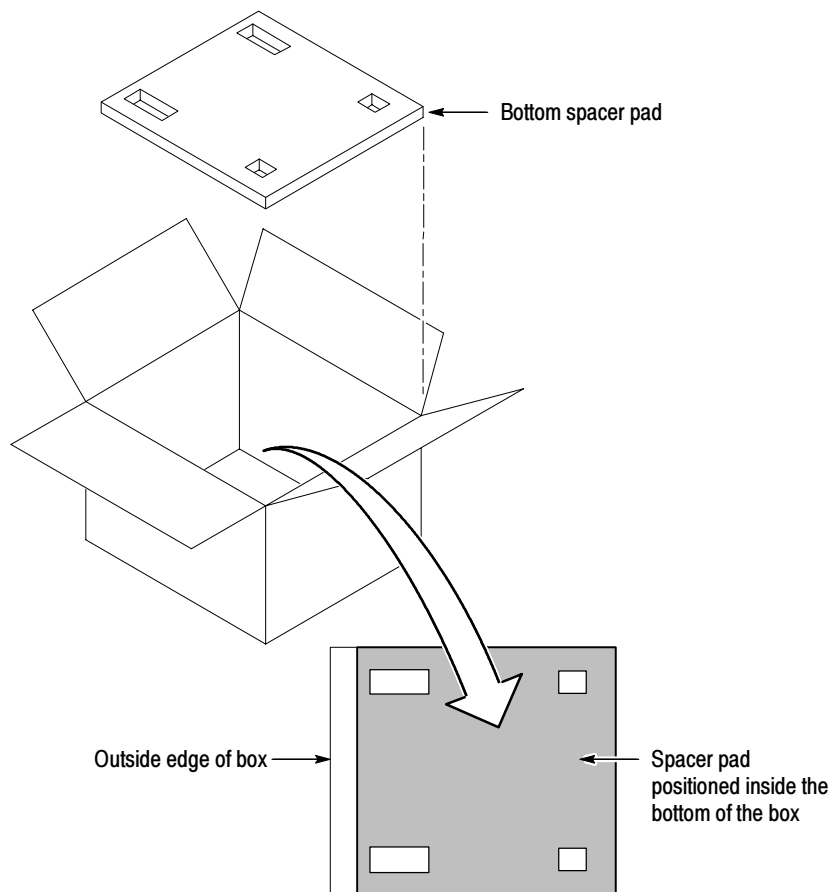
**Note:** *The keyboard, mouse, and manual boxes do not need to be returned with the instrument for servicing.*

**Figure B-2: Repackaging the instrument (old packaging)**



The inner shipping box, pads, and protective bag provide the necessary protection to allow the shipping materials of the outer shipping box to correctly support the product for shipment. Pack the inner shipping box as follows:

1. If an instrument is to be shipped to a Tektronix field office for repair, attach a tag to the instrument showing the following:
  - Owner's name and address
  - Instrument serial number
  - Description of the problem(s) encountered and/or service required.
2. If you have the original packaging material, start by placing one of the spacer pads in the bottom of the inner box (3). Position the side of the pad with the smaller, square holes against the side of the box as shown in Figure B-3.



**Figure B-3: Placement of bottom spacer pad in inner shipping box**

3. Place the protective front cover on the front of the instrument.
4. Place the instrument in the protective bag. The bag prevents dust, moisture, or other debris from entering the cabinet.
5. Fold the top of the bag neatly over the top of the instrument to make it as flat as possible and seal with packing tape.
6. Place the bagged instrument in the inner shipping box. The small feet on the bottom of the cabinet go in the square holes in the spacing pad and the larger feet near the front of the instrument go in the larger rectangular holes. The bezel end of the cabinet fits over the edge of the spacer pad.
7. Place the other spacer pad on top of the instrument. Place the side with the small square holes against the side of the box. The protective front cover on the bezel of the instrument is not covered by the top spacer pad.
8. Close and tape the inner shipping box (3).
9. Place one of the support inserts (4) in the bottom of the outer shipping box, film side up as shown in Figure B-2.
10. Place the sealed inner shipping box (3) in the center of the bottom support insert in the outer shipping box (4).
11. Put the second support insert (2) over the inner shipping box, film side down.

---

**NOTE.** *It may be necessary to pre-stretch the film in the support inserts by pushing down firmly several times on the top support insert.*

---

12. Place the top tray (1) in the box. If you are not shipping accessories with the instrument, close and tape the outer shipping box (5).
13. When shipping the accessories, place the two accessory trays in the top tray, then arrange the accessories in the trays.
14. Close and tape the outer shipping box (5).
15. Attach the appropriate shipping documents needed to ship the instrument to its destination.

# Appendix C: System Recovery

If you have problems with either BIOS configuration or system/application software, use the procedures in this section to restore the system to factory default installation and configuration.

---

**NOTE.** *If you are restoring software after replacing the hard disk drive with one you ordered as a replacement from Tektronix, follow the instructions provided with the hard disk drive replacement.*

*If you are restoring software after reformatting the hard drive, perform all of the procedures in this section in sequence.*

---

## Overview

These procedures require the *RFA300A System and Application Restore Media* CD-ROM, which was shipped with the RFA300A Measurement Set 8VSB.

Installation should only be performed by a qualified technician who is familiar with installing drivers and configuring for networking.

These tips apply to the procedures in this section:

- Use default settings unless otherwise indicated in the following procedures.
- These procedures use drive “e:” as the CD-ROM drive.
- At the end of some steps, you are instructed to restart the system. To do this, if you are prompted to restart, select **Yes**. If not prompted, select **Shutdown** from the Start menu and then select **Restart the computer**.

You can use the procedures in this section to do any of the following:

- Restore the system BIOS settings to factory defaults.
- Restore a part of the system.
- Restore the complete system, including installation and configuration, to factory defaults.

The complete system includes:

- Microsoft Windows NT 4.0
- Automatic logon for Windows NT 4.0
- Network Netbeui protocol and Network TCP/IP printing service
- ES1869 Sound Driver
- Chip and Technology 69000 Display Driver
- Tektronix JPS software
- Windows NT Service Pack 5
- Intel EtherExpress PRO/100B PCI Adapter Driver
- Touch-Base SC3 Touch Screen Driver
- My-T-Soft NT soft keyboard
- Microsoft ODBC
- Microsoft Data Access Object
- Tektronix RFA300A Measurement Set 8VSB application software

## Restore the BIOS Settings



---

**CAUTION.** *The RFA300A Measurement Set 8VSB is programmed with custom BIOS settings; choosing any other settings will cause instrument malfunction. Do not use the setup defaults of the BIOS manufacturer.*

---

The *RFA300A System and Application Restore Media* CD-ROM contains a utility CMOS NVRAM read/write program and a factory-customized BIOS image. When the RFA300A Measurement Set 8VSB is booted from the CD-ROM, the *readme.txt* file will display instructions.

### Boot Options

The RFA300A Measurement Set 8VSB is set at the factory to boot from a removable device, CD-ROM, hard drive, and then network. If this has been changed, you must reset the boot options before you can restore the BIOS settings from the CD-ROM.

To reset the boot options, perform the following procedure:

- Reboot the RFA300A Measurement Set 8VSB.
- Press **F2** to enter BIOS setup when prompted on system startup.
- Go to the **BOOT OPTIONS**.
- Change the **BOOT ORDER** to:  
removable device, CD-ROM, hard-drive, and then network boot.
- Exit with **Save Settings**.

### Restore BIOS settings from the CD-ROM

To reprogram the CMOS NVRAM to the custom factory settings for the BIOS, perform the following steps:

1. Power up the RFA300A Measurement Set 8VSB with the *RFA300A System and Application Restore Media* CD-ROM in the CD-ROM drive.
2. Enter *Restbios.bat* at the DOS prompt. The BIOS settings will be reset.

To manually configure the BIOS settings, refer to the *RFA300A Measurement Set 8VSB Service Manual* for settings and instructions.

## Restore the Contents of the Partitions

In some situations, such as when the power has been interrupted, or files were mistakenly deleted, the RFA300A may fail to boot from the hard drive. If this happens, use the *RFA300A System and Application Restore Media* CD-ROM to restore the hard drive to factory default installation status.

The RFA300A Measurement Set 8VSB contains one IDE hard drive with two partitions. The first partition, used for the RFA300A system, is approximately 2000 MB and is formatted with the FAT format. The second partition uses all of the remaining space on the hard drive, and is formatted with NTFS.

### Easy Restore Partition 1

To restore the contents of partition 1 only (NT system and RFA300A application), use the following steps. This restore process is effective only if the hard drive is still good. The process should take less than 15 minutes.)



---

**CAUTION.** *The following procedure should preserve the data on Partition 2 (D: drive). However, under some extreme conditions, such as problems with the partition table or Partition 2, the data may be lost. Therefore, you should back up important data on disks or over the network before beginning this procedure.*

---

1. Power up the RFA300A Measurement Set 8VSB with the *RFA300A System and Application Restore Media* CD-ROM in the CD-ROM drive.
2. Enter `restp1.bat` at the DOS prompt.
3. Click **Continue** when prompted.
4. In the warning dialog box, confirm with **Yes**. A window will show the progress of the restore function.
5. Remove the CD-ROM from the drive and restart the system when prompted.

**Easy Restore  
Partitions 1 & 2**

If Partitions 1 and 2 are both corrupted or you want to restore the hard drive to factory status, use the *Partition 1* procedure on page C-4, except replace restp1.bat with restdisk.bat. This will remove all of the data from both partitions.

**Create Partition 2**

To restore only Partition 2 to factory status, removing all data from Partition 2 without removing data from Partition 1, you can use the following procedure. This procedure uses the Windows NT Disk Administrator tool to create a new Partition 2. After you create Partition 2 using this procedure, if you later use the *Easy Restore Partition 1* procedure on page C-4, Partition 2 will be preserved in most cases.

---

**NOTE.** *You typically do not need to use this procedure; the Easy Restore procedures are normally sufficient to restore Partitions 1 and 2.*

---

To create Partition 2, perform the following steps:

1. From the Start menu, select **Program, Administrative Tools**, and then **Disk Administrator**.
2. Click **CD-ROM**.
3. From the Tools menu, select **Assign Drive Letter**.
4. Select **E:** for the CD-ROM.
5. Click the unpartitioned space on disk 1.



---

**CAUTION.** *It is important to select **Create Extended** in the following step.*

---

6. From the Partition menu, select **Create Extended** to create an extended partition. Use all of the remaining free space.
7. From the Partition menu, select **Commit Change Now**.
8. Click within the partition that you just created.
9. From the Partition menu, select **Create** to create a logical drive. Use all of the free space. Assign drive letter **D:** if needed.
10. From the Partition menu, select **Commit Change Now**.
11. From the Tools menu, select **Format the new partition**. Format it with the **NTFS file system**.

## Install and Configure Individual Components

If a component is malfunctioning, reinstall or reconfigure the driver or software individually. This may save you from having to restore the entire partition.

### Install ESS Technology ES1869 Sound Chip Driver

Make sure that the *RFA300A System and Application Restore Media* CD-ROM is in the CD-ROM drive.

1. From the Start menu, select **Control Panel**.
2. In the Control Panel, select **Multimedia**.
3. In the Device tab, select **Audio Devices**.
4. Select **ES1879/1869/1878/1868/1887/1888 Audio** and click the **Remove** button.
5. Restart the system.
6. In the Control Panel, select **Multimedia**.
7. In the Device tab, select **Audio Devices**.
8. Select **Audio Device** and click the **Add** button.
9. Select **Unlisted or UPdated Driver**.
10. Specify the **E:\Drivers\Essaudio** directory as the driver location.
11. Click **OK** to install the ES1879/1869/1878/1868/1887/1888 Audio driver.
12. Remove the CD-ROM from the drive and restart the system.

### Install Chip and Technology 69000 Display Driver

Make sure that the *RFA300A System and Application Restore Media* CD-ROM is in the CD-ROM drive.

1. From the Start menu, select **Control Panel**.
2. In the Control Panel, select **Display**.
3. Select the **Settings** tab.
4. Click the **Display Type...** button.
5. Click the **Have Disk...** button.
6. Click the **Change...** button.
7. Specify the **e:\Drivers\ChipsTec** directory as the driver location.
8. After the disk is scanned and the driver is installed, remove the CD-ROM from the drive and restart the system.



## Configure the Display

1. From the Start menu, select **Control Panel**.
2. In the Control Panel, select **Display**.
3. Select the **Settings** tab.
4. Set the Screen Area to **640 by 480 pixels**.
5. Set the Colors to **16777216 colors**.

## Configure the COM Ports

1. From the Start menu, select **Control Panel**.
2. In the Control Panel, select **Ports**.
3. Click the **Add** button to add a COM Port. You need COM1, COM3, and COM4. If COM3 and COM4 are not present, add them. If COM2 is configured, delete it.
4. Configure COM1 as follows:

Input/Output Range	3F8-03FF
Interrupt Request	10
Bits per second	9600
Data bits	8
Parity	None
Stop bits	1
Flow control	None
5. Configure COM3 as follows:

Input/Output Range	03E8-03EF
Interrupt Request	04
Bits per second	2400
Data bits	8
Parity	None
Stop bits	1
Flow control	None
6. Configure COM4 as follows:

Input/Output Range	02E8-02EF
Interrupt Request	03
Bits per second	9600
Data bits	8
Parity	None
Stop bits	1
Flow control	None
7. Restart the system.

### **Install the Tektronix JPS Software**

Make sure that the *RFA300A System and Application Restore Media* CD-ROM is in the CD-ROM drive.

1. From the Start menu, run **E:\Drivers\Tekjps\Setup.exe**.
2. Click **Next** in the Choose Destination Directory dialog box.
3. Click **Next** to continue.
4. Check **Yes, I want to restart my computer now**, and click **Finish**.
5. Remove the CD-ROM from the drive and restart the system.

### **Install the Soft Power Off**

Make sure that the *RFA300A System and Application Restore Media* CD-ROM is in the CD-ROM drive.

1. Open a DOS command window (from the Start menu, select **MSDOS Prompt**).
2. Go to **"e:\Drivers\PowerOff"**.
3. Run **"regini jamshut.ini"**.
4. Copy **"jamshut.sys"** to **"c:\winnt\system32\drivers"**.
5. Run **"regini jamsrv.ini"**.
6. Copy **"jamsrv.exe"** to **"c:\winnt\system32"**.
7. Remove the CD-ROM from the drive and restart the system.

### **Install the Intel EtherExpress PRO/100B PCI Adapter**

Make sure that the *RFA300A System and Application Restore Media* CD-ROM is in the CD-ROM drive.

1. Copy **"e:\Drivers\EtherExp"** to **"c:\Temp"**. (It is not possible to install the drivers directly from the CD-ROM.)
2. From the Start menu, select **Settings**, and then **Control Panel**.
3. In the Control Panel, select **Network**, and then select the **Adapter** tab.
4. If an adapter other than the **"Intel (R) PRO/100B PCI Adapter (Tx)"** is displayed, remove the displayed adapter and add the correct adapter.
5. Click the **Have Disk...** button and then click the **Update** button.
6. Specify the **"c:\Temp\EtherExp"** directory as the driver location.
7. Specify the network configuration information (such as the IP address) for this RFA300A Measurement Set 8VSB on your network. Consult your network administrator for the network configuration information.

8. After the driver installation completes, remove the CD-ROM from the drive and restart the system.

### Install the Touch-Base SC3 Touch-Screen Driver

Make sure that the *RFA300A System and Application Restore Media* CD-ROM is in the CD-ROM drive.

1. From the Start menu, run “**e:\drivers\TouchBas\tnsetup.exe**”.
2. Select touch-screen type: DynaPro-Serial, SC3.
3. Click **OK** to continue.
4. Select the following communication port settings in the Hardware Controls (Serial) dialog box.

Com Port:	COM 3
Address:	3E8
IRQ:	4
Baud Rate:	2400
Parity:	None
Data Bits	8
Stop Bits	1
5. Remove the CD-ROM from the drive and restart the system.
6. From the Start menu, select **Programs, Touch,** and then **TouchScreen Control**.
7. Click the **Calibration** button to perform calibration.
8. Follow the instructions to calibrate the touch screen.
9. Click the **User Controls** button and then click the **Sound** check box to deselect sound.

### Install the My-T-Soft NT Soft Keyboard Driver

Make sure that the *RFA300A System and Application Restore Media* CD-ROM is in the CD-ROM drive.

1. From the Start menu, run “**E:\Drivers\Mytsoft\SETUP.EXE**”.
2. Follow the default options to install the driver.
3. Restart the machine as instructed.
4. After restart, in the My-T-Soft group, double-click My-T-Soft Setup to start the setup.
5. On the My-T-Soft Setup utility, click on the keyboard.
6. Make sure the International Keyboard is set to US.

7. Click OK.
8. Click Exit to exit My-T-Soft Setup.
9. Remove the CD-ROM from the drive and restart the system.

**Install Windows NT  
Service Pack 5**

Make sure the *RFA300A System and Application Restore Media* CD-ROM is in the CD-ROM drive.

1. From the Start menu, run “**e:\SP5\sp51386.exe**”.
2. Follow the Windows NT installation instructions. Do not override the E100B.SYS.
3. Remove the CD-ROM from the drive and restart the system when installation is completed.

**Install Database and  
RFA300A Measurement  
Set 8VSB Software**

Make sure that the *RFA300A System and Application Restore Media* CD-ROM is in the CD-ROM drive.

1. Install ODBC30 by running “**e:\ODBC30\Setup.exe**” from the Start menu.
2. Install DAO30 by running “**e:\DAO30\Setup.exe**” from the Start menu.
3. Install the RFA300A Measurement Set 8VSB software as follows:
  - a. From the Start menu, run “**e:\RFA300A\Setup.exe**”.
  - b. Click **Next**.
  - c. Select **Typical** setup type.
  - d. Click **Next**.
  - e. Click **OK** to acknowledge the comctl32.dll update.
  - f. Click **Finish** for the pass 1 setup.
  - g. Remove the CD-ROM from the drive to let the system boot from the hard drive.
  - h. As soon as the NT boot starts from the hard drive, reinsert the CD-ROM into the drive.
  - i. The system completes the NT boot from the hard drive and then uses the CD-ROM for pass 2 of the setup.
  - j. When you are prompted to finish, remove the CD-ROM from the drive and click to restart the system. The RFA300A Measurement Set 8VSB will be available for use after the restart.

## Additional Configuration

1. Set auto-hide for the task bar as follows:
  - a. From the Start menu, select **Setting**, and then **Taskbar**.
  - b. Check **Auto Hide**.
  - c. Click **OK**.
2. Configure automatic logon (to allow the RFA300A to automatically log on when you start the system or reboot) as follows:
  - a. From the Start menu, run **E:\tools\autologon.exe** (where **E** is the CD-ROM drive letter).
  - b. Enter the user name: **Administrator**.
  - c. Enter the password: **RFA300A**.
  - d. Click **OK**.
3. Set the Event Viewer as follows:
  - a. From the Start menu, select **Programs, Administrative tools**, and then **Event Viewer**.
  - b. From the Event Viewer Log menu, select **Log Settings**.
  - c. Select **Overwrite events as needed** for the **Application, System**, and **Security logs**.
  - d. Exit the Event Viewer.
4. Set the Microsoft Explorer options as follows:
  - a. Open Microsoft Explorer.
  - b. Under View, select **Options**.
  - c. Select **Show all files**.
  - d. Deselect **Hide file extensions for known file types**.
5. Set boot initialization countdown as follows:
  - a. From the Start menu, select the **Control Panel**.
  - b. In the **Control Panel**, double-click the **System** icon.
  - c. Select **Startup/Shutdown** tab.
  - d. Change the **Showlist for** to **3 seconds**.

This completes the *Software Installation Procedure*.



## Appendix D: Mask File Formatting

The mask-testing feature allows you to set visual parameters within the graphic portion of the measurement window. The masks are lines against which you can compare waveforms.

To create your own mask files you must understand how they are formatted. This section provides that information. For information on creating a specific mask, refer to the online help: for example, *Creating Out of Channels Emission masks*.

Mask files have the following generic format:

- Mask files are stored as text files. You can create them using a text editor.
- The extension on a mask file must be of the form “.mskxx” where xx is an integer representing the ResultID value for the mask test result for this file (see Line 1 below).
- Mask files must be placed in C:\RFA300\Masks to be recognized.

The format of mask files is as follows:

- Lines are delimited with the newline character.
- Numbers on a line are comma delimited (the newline character is typically generated with a carriage return in most text editors).
- Line lengths are limited to 200 characters maximum.
- Line 1 contains the ResultID value for the mask test result for this file. Refer to Table D-1.
- Line 2 contains a note associated with the file.
- Line 3 contains a number that represents the number of points in the mask.
- Lines 4 through x each contain one point in the mask. The format of this line is (x, y1, y2), or (y, x1, x2). Normally masks are of the first form. If the mask has a single value per x location, it will be (x, y1), otherwise if it has two values per x location (for example, a min and a max), it will be of the form (x, y1, y2).
- A mask of the form (y, x1, x2) is one which does not necessarily have a value for all x locations. x and y numbers are in integer or scientific format.

Table D-1 lists the ResultID for each type of mask.

**Table D- 1: ResultID Values for Mask Tests**

<b>Mask test</b>	<b>ResultID</b>
Frequency Response	69
Group Delay	70
Phase Error	81
Phase Noise	77
Amplitude Error	80
Out of Channel Emissions	62



# Glossary

**Alarm Limit**

A parameter set in the Limits dialog box. When a measurement exceeds the parameter, you are notified in the measurement or Signal Monitor window.

**Amplitude Error**

An error that is typically caused by an amplifier's gain changing because of signal amplitude. The measurement set plots the signals instantaneous amplitude error as a function of amplitude.

**AutoScale**

Sets the scale factor for both axes to default values.

**Bit Error Ratio (BER)**

The ratio of bits correctly received to bits received in error.

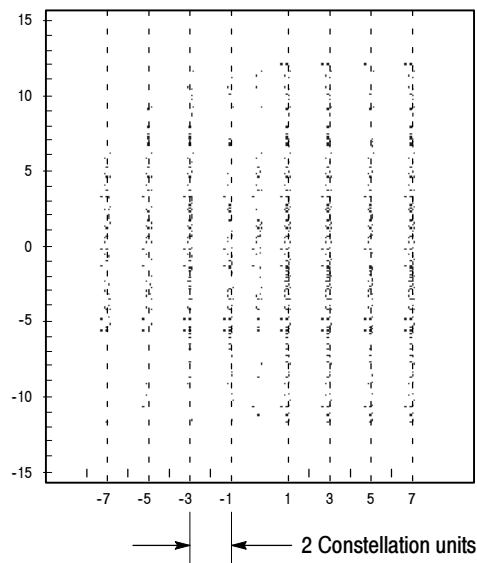
**Caution Limit**

A parameter set in the Limits dialog. When a measurement exceeds the parameter, you are notified in the measurement or Signal Monitor window. Caution limits are typically set to warn you when the measurement is close to exceeding the Alarm limit.

**Constellation Unit**

A unit half of the minimum distance between two digital (8VSB) symbols. This is illustrated next using the constellation graph of the EVM window. Note that a constellation unit is half of the minimum distance between two I-channel constellation levels.

Many measurements are made in constellation units. Unit size remains constant while the Digital Television signal varies in amplitude.



**Frequency Response**

The variation of signal amplitude over a channel’s frequency range.

**Group Delay**

The relative time of propagation of packets of information at frequencies in the spectrum of a waveform.

**Limits Set**

A set of caution and alarm parameters against which numeric measurement results are compared.

**Mask**

A visual parameter within the graphic portion of the measurement window against which acquired waveforms are compared.

**Peak Transient Power**

The maximum value of envelope power occasionally reached by a digitally modulated signal.

**Phase Error**

An error typically caused by variation of an amplifier's phase changing because of signal amplitude. The measurement set plots the signals instantaneous phase error as a function of amplitude.

**Phase Noise**

A noise typically added to the digital modulation by the transmitter's frequency synthesizer system. The measurement set measures the pilot's phase noise.

**Result**

The outcome of a measurement in numeric, pass/fail, and graphic forms.

**Results Database**

A file where results from a measurement are held for later recall, exporting, or reporting. Data in these files can also be used for further study or analysis by external applications. The files are in Microsoft Access format.

**Signal to Noise**

The power ratio between the ideal received signal and the difference between the ideal and actual received signal along the real axis.

**Session**

A collection of any results saved by the Signal Monitor during the time between the Run and Stop events. A session can include a few results or the results from many iterations through a set of measurements.

**Setup**

A collection of instrument control settings that includes measurement, monitoring, and viewing parameters. Setups do not include any option settings or system frequency selection.



# Index

## Numbers

8VSB overview, 3-14

## A

Accessories, 1-4  
Address, Tektronix, x  
Alarm Limit, definition, Glossary-1  
Amplitude Error, Glossary-1  
Amplitude Error setup, 3-9  
Amplitude Error window, 3-8  
Automatic logon, C-11  
AutoScale, definition, Glossary-1

## B

BIOS settings, restore, C-3  
Bit Error Ratio, definition, Glossary-1  
Boot installation countdown, C-11  
Boot options, C-3

## C

Caution Limit, definition, Glossary-1  
Channel frequency, 1-18  
Channel selection, 1-18  
Channel Spectrum window, 3-10  
Cleaning, B-1  
COM port configuration, C-7  
Configuration, C-11  
Configure the COM ports, C-7  
Configure the display, C-7  
Connections, 1-16  
Constellation unit, definition, Glossary-2  
Contacting Tektronix, x

## D

Diagnostics  
  descriptions, B-3  
  extended, 1-20  
Display driver, C-6

## E

Environmental characteristics, A-14  
Error Vector Magnitude window, 3-3  
Event viewer configuration, C-11  
Extended diagnostics, 1-20

## F

Frequency Response, definition, Glossary-2  
Frequency Response setup, 3-7  
Frequency Response window, 3-6  
Frequency, channel, 1-18  
Front panel, 2-1

## G

General care, B-1  
Group Delay, definition, Glossary-2  
Group Delay setup, 3-7  
Group Delay window, 3-6

## H

Hard drive restore, C-4  
Hardware installation, 1-6  
Hardware problems, B-4  
Help, online, 2-9  
Home window, 1-2, 2-4

## I

Incoming inspection, 1-20  
Input signal, 1-18  
Installation, 1-5  
  hardware, 1-6

## J

JSP software, C-8

## K

Keyboard driver, C-9  
Keyboard, soft, 2-3  
Keypad, 2-1

## L

Limits Set, definition, Glossary-2  
Limits, creating, 2-6

## M

Maintenance, preventive, B-1  
Making a measurement, 2-6  
Mask, 2-7  
    Amplitude Error, 3-9  
    definition, Glossary-2  
    Frequency Response, 3-7  
    Group Delay, 3-7  
    Out of Channel Emissions, 3-2  
    Phase Error, 3-9  
    Phase Noise, 3-5  
Measurement functionality, verifying, 1-20  
Measurement specifications, A-4  
Mechanical characteristics, A-18  
Menus, 2-4  
MER, complex window, 3-3  
Microsoft Explorer options, C-11  
My-T-Soft keyboard, 2-3  
My-T-Soft Keyboard driver, C-9

## O

On/Standby switch, 1-17  
Online help, 2-9  
Operating requirements, 1-6  
Out of Channel Emissions window, 3-1  
Out of Channels Emissions Setup, 3-2

## P

Packaging for shipment, B-5  
Packaging replacement, B-6  
PCI adapter, C-8  
Peak Transient Power, Glossary-2  
Peak-to-Average setup, 3-11  
Peak-to-Average window, 3-10  
Phase Error, Glossary-3  
Phase Error setup, 3-9  
Phase Error window, 3-8  
Phase Noise, Glossary-3  
Phase Noise Setup, 3-5  
Phase Noise window, 3-4  
Phone number, Tektronix, x  
Pilot Amplitude window, 3-3  
Portable installation, 1-12

Power-on procedure, 1-17  
Preventive maintenance, B-1  
    cleaning, B-1  
    compact disk drive, B-2  
    display, cleaning, B-2  
    keyboard, B-3  
    mouse, B-3  
Problems  
    hardware, B-4  
    software, B-3  
Product description, 1-1  
Product support, contact information, x

## R

Rackmount installation, 1-7  
Recover software, C-1  
Repacking for shipment, B-5-B-10  
Requirements for operating, 1-6  
Restore BIOS settings, C-3  
Result, definition, Glossary-3  
Results Database, Glossary-3  
RF connections, 1-14  
RFA300 Measurement Set 8VSB, description, 1-1  
RFA300A software, C-10

## S

Saved files, backing up, 2-10  
Saving results, 2-7  
Selecting the channel frequency, 1-18  
Selecting the RF input channel, 1-18  
Service support, contact information, x  
Service, user, preventive maintenance, B-1  
Session, definition, Glossary-3  
Setup  
    Amplitude Error, 3-9  
    definition, Glossary-3  
    Frequency Response, 3-7  
    Group Delay, 3-7  
    Out of Channels Emissions, 3-2  
    Peak-to-Average, 3-11  
    Phase Error, 3-9  
    Phase Noise, 3-5  
    Signal Monitor Setup, 3-13  
Shipping, B-5  
Signal Monitor, tutorial, 2-7  
Signal Monitor setup, 3-13  
Signal Monitor window, 3-12  
Signal to Noise, Glossary-3  
Signal-to-Noise window, 3-3

Soft keyboard, 2-3  
Soft keyboard driver, C-9  
Soft power off, C-8  
Software problems, B-3  
Software recovery, C-1  
Sound chip driver, C-6  
Specification, measurement, A-4  
Specification tables, definition, A-1  
Starting measurements, 2-7  
Startup disks, 1-13  
Stopping measurements, 2-7  
system component characteristics, A-9  
System Recovery, C-1

## T

Target Operating Point, Peak-to-Average, 3-11  
Technical support, contact information, x  
Tektronix, contacting, x  
Touch screen, 2-3  
Touch-screen driver, C-9  
Troubleshooting, B-3  
Tutorial, 2-6

## U

URL, Tektronix, x  
User service  
    general care, B-1  
    preventive maintenance, B-1

## V

Verifying functionality, 1-20  
Verifying input signal power, 1-18  
Viewing results, 2-7

## W

Web site address, Tektronix, x  
Window  
    Amplitude Error, 3-8  
    Channel Spectrum, 3-10  
    Complex MER, 3-3  
    Error Vector Magnitude, 3-3  
    Frequency Response, 3-6  
    Group Delay, 3-6  
    Home, 1-2, 2-4  
    Out of Channel Emissions, 3-1  
    Peak-to-Average, 3-10  
    Phase Error, 3-8  
    Phase Noise, 3-4  
    Pilot Amplitude Error, 3-3  
    Signal Monitor, 3-12  
    Signal-to-Noise, 3-3  
Windows NT Service Pack, C-10

